



REV.NO.:0

承 认 书
SPECIFICATION FOR APPROVAL

ROHS

品 名 Part Name	INDUCTOR
风华规格 FH. PartNumber	VLU0810-680K
客户料号 Part NO.	
规格书编号 Document NO.	VLU0810-YH160201

请客户承认后回签本公司
 Please return one copy after approved

变更记录表

Alter Record

版本 REV.	修改内容 Change Description	日期 Date	修改人 Drafted By	审核 Checked By	批准 Approved By
0	出图	2016-5-5			

广东风华高新科技股份有限公司
 FENGHUA ADVANCED TECHNOLOGY (HOLDING) CO., LTD.
 地址: 广东省肇庆市风华路风华工业园 6 号楼 3
 楼电感分公司.
 Tel:0758-6923466
 Fax:0758-2223674-8014
 E-mail:dg@fenghua-yuehua.com

拟制 Designer	审核 Checker	批准 Approver
侯庆穆	李荣浩	李有敏

1. DIMENSION AND WINDING / 卷线规格和外观寸法图 [单位 mm]

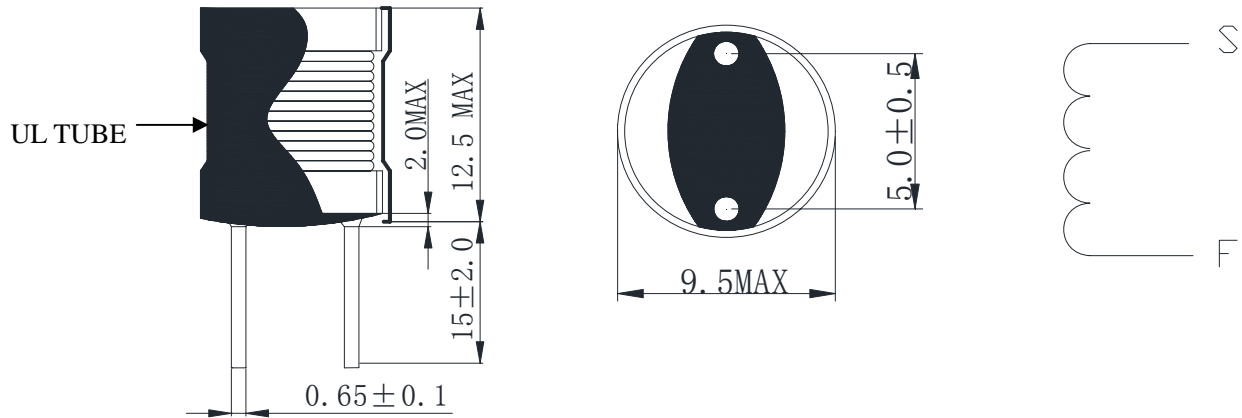

2. WINDING SPEC. / 卷线规格

COIL / 线圈	WIRE / 线材	TURNS / 圈数
N1	2UEW ϕ 0.40	44.5T(ref)

3. ELECTRICAL CHARACTERISTICS / 电气特性

ITEM / 项目	PIN NO. / 测定端子	SPEC. / 规格	CONDITION • EQUIPMENT / 测定器 • 条件	
INDUCTANCE 电感	S--F	68 μ H \pm 10%	MICROTEST 6377+6220 or EQUIVALENT (f=1KHz, 1V)	
RATED CURRENT 额定电流	S--F	$\Delta L/L \leq -10\%$	1.5A MAX	MICROTEST 6377+6220 or EQUIVALENT 1kHz, 1V, at 25°C
DC R 电阻	S--F	0.138 Ω MAX	CH3205 25°C or EQUIVALENT	

4. MATERIAL LIST / 材料明细表

NO	COMPONENT 部品名	MATERIAL 材质	MATERIAL SPEC. 材料规格
1	CORE 磁芯	FERRITE 铁氧体	SR60 DRW8*10FSO C4.0 E6.0 P5.0 or EQUIVALENT
2	WIRE 线材	POLYURETHANE COPPER 聚氨酯甲酸酯铜线	2UEW ϕ 0.40mm
3	UL TUBE UL 套管	PYROCONDENSATION TUBE 热缩套管	ϕ 9 mm
4	ADHESIVE 粘合剂	EPOXY 环氧树脂	FK661-506 OR EQUIVALENT



广东风华高新科技股份有限公司
FENGHUA ADVANCED TECHNOLOGY (HOLDING) CO., LTD.

MODEL NO. : VLU0810-680K

PART NO. :

PART NAME : INDUCTOR

DESIGNER: 侯庆穆

CHECKER: 李荣浩

APPROVER: 李有敏