

Recommended PCB Layout

SPECIFICATIONS

- 1.RATING: DC30V 1.0A
 - 2.MECHANICAL LIFE: 10,000 CYCLES.
 - 3.PACKAGING: 1000PCS/REEL
- 备注：平口/无卷边

③	Shell	—	1	Phosphor Bronze	Ag Plated	—
②	Contact	—	5	C2680R-H	Au Plated	—
①	Housing	—	1	LCP	Black	—
ITEM	PART NAME	TER'NO.	QTY.	MATERIAL	FINISHING	REMARK
APPROVALS		DATE				
DRAWN		JIANKUN.LU	2015.5.29	TITLE: USB CONNECTOR		
CHECKED				ELECTRONICS CO.,LTD		
APPROVALS				PART NO. U-C-M5DD-W-1		
TOLERANCES ARE		30~45 ±0.35	ANGLE	UNIT: mm	SCALE: 1:1	PROJ. SHEET 1 OF 1
		10~30 ±0.25				
		5~10 ±0.20	±2'	DRAWING NO.		
		~ 5 ±0.15				

ECN NO.	REV.	DATE.	DESCRIPTION.	CHANGE.	CHECK.	APPRO.
	A		NEW			

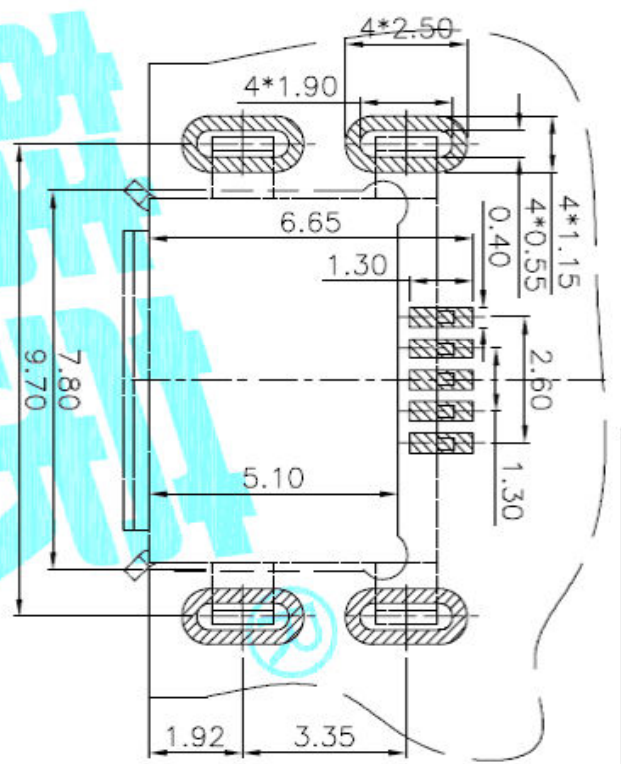
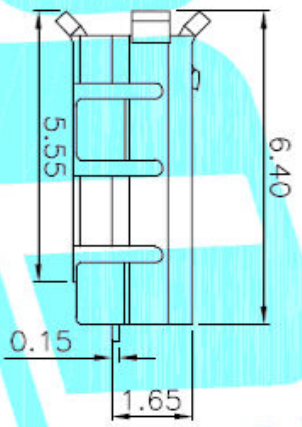
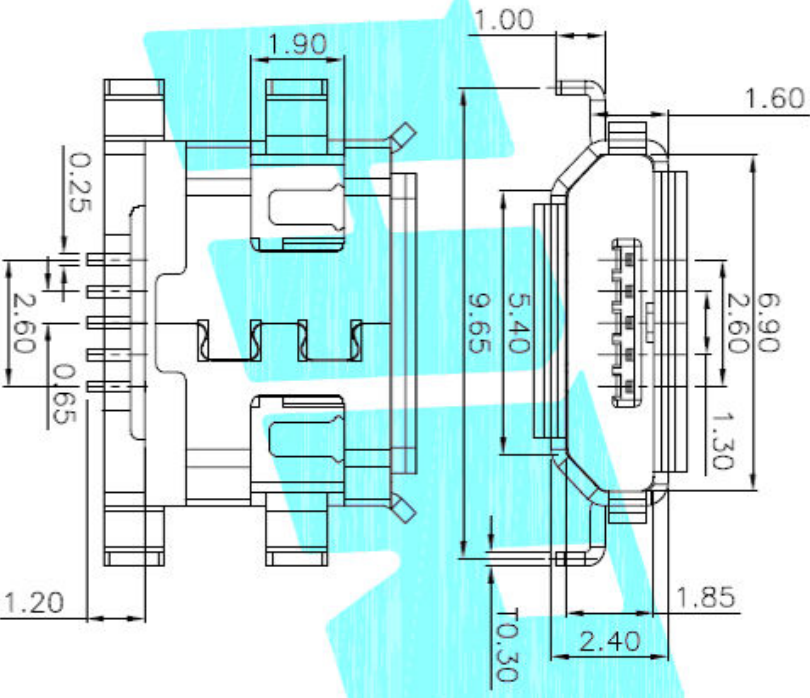
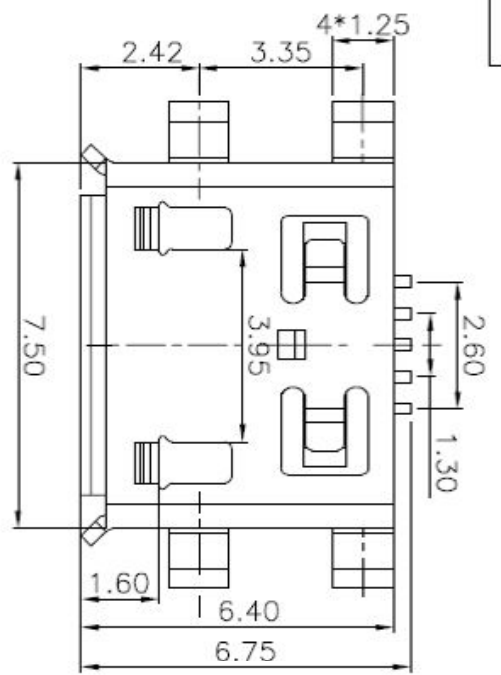

Recommended PCB Layout

SPECIFICATIONS

- 1.RATING: DC30V 1.0A
- 2.MECHANICAL LIFE: 10,000 CYCLES.
- 3.PACKAGING: 1000PCS/REEL

ECN NO.	REV.	DATE.	DESCRIPTION.	CHANGE.	CHECK.	APPRO.
	A		NEW			

APPROVALS		DATE	TITLE: USB CONNECTOR	
DRAWN		JHANKUN.LU 2015.5.29	PART NO. U-C-M5DD-Y-1	
CHECKED			ELECTRONICS CO.,LTD	
APPROVALS			SCALE: 1:1	
TOLERANCES ARE		30~ULT ±0.30	ANGLE	UNIT: mm
		10~30 ±0.25	±2°	SCALE: 1:1
		5~10 ±0.20		PROJ. SHEET 1 OF 1
		~5 ±0.15		



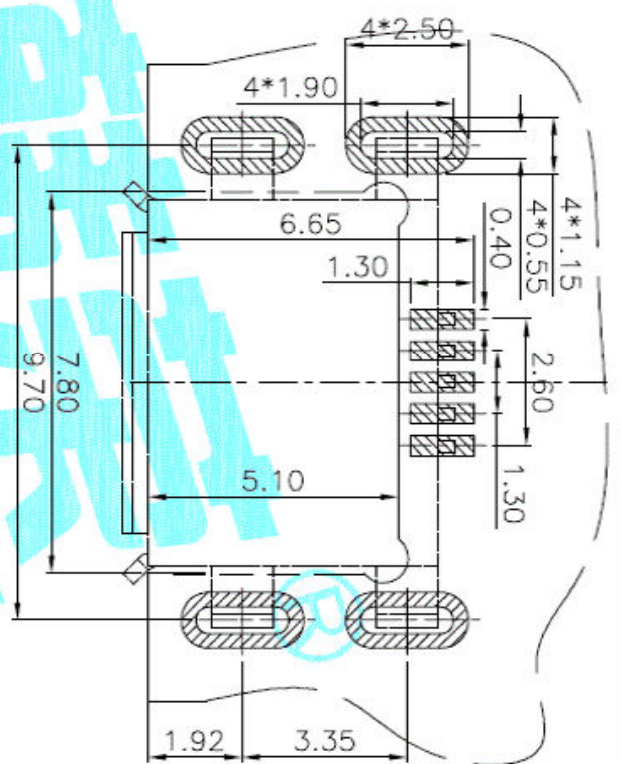
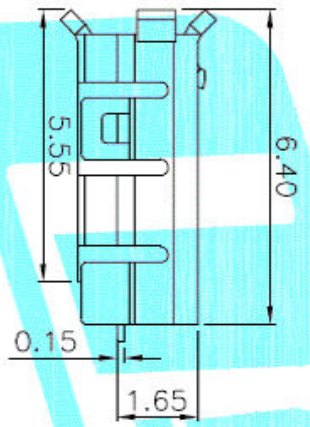
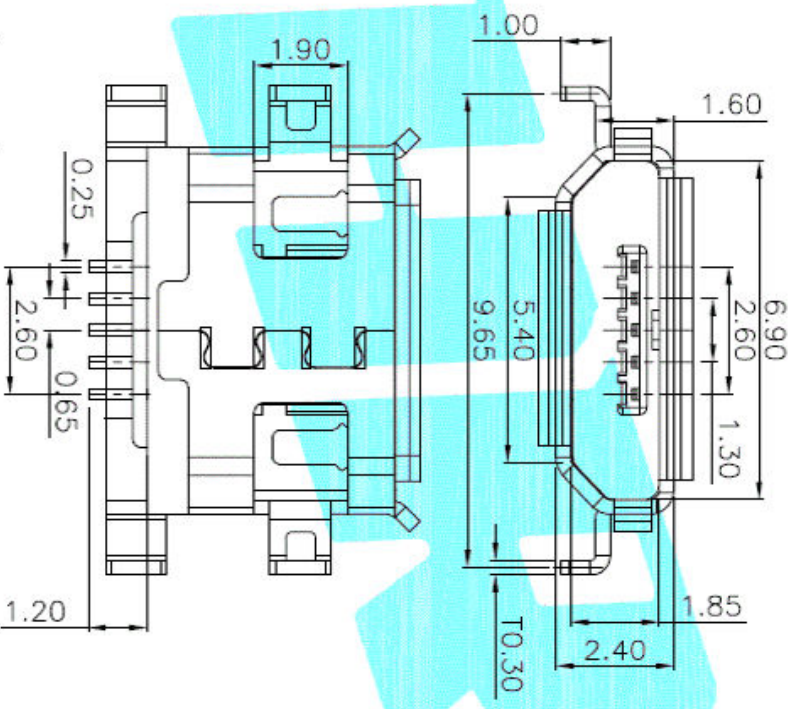
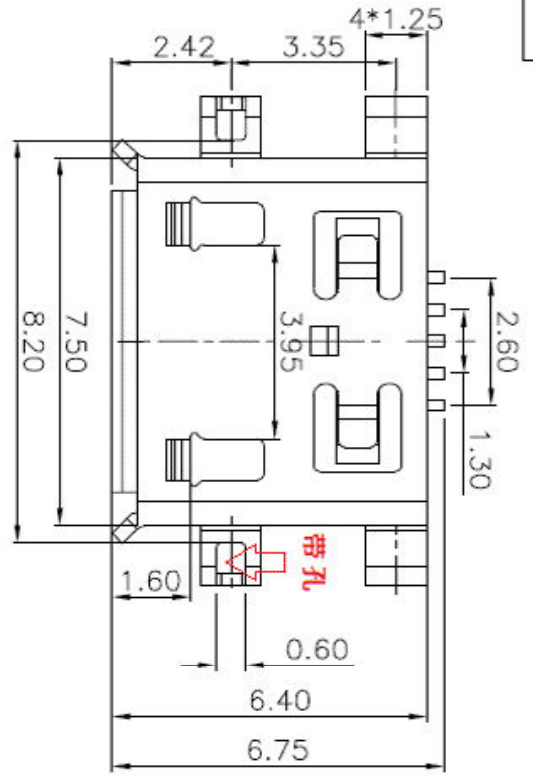

Recommended PCB Layout

SPECIFICATIONS

- 1. RATING: DC30V 1.0A
- 2. MECHANICAL LIFE: 10,000 CYCLES.
- 3. PACKAGING: 1000PCS/REEL

③ Shell	—	1	Phosphor Bronze	Sn Plated	—	
② Contact	—	5	C2680R-H	Au Plated	—	
① Housing	—	1	LCP	Black	—	
ITEM	PART NAME	TER'NO.	QTY.	MATERIAL	FINISHING	REMARK
APPROVALS		DATE	TITLE: USB CONNECTOR			
DRAWN JKUN.LU		2015.3.29	ELECTRONICS CO.,LTD			
CHECKED			PART NO. U-C-M5DD-Y-2			
APPROVALS			SCALE: 1:1			
TOLERANCES ARE		30~ULT. ±0.36	ANGLE	UNIT: mm	SCALE: 1:1	PROJ.
		10~30 ±0.25				
		5~10 ±0.20	±2'	DRAWING NO.		SHEET 1 OF 1
		~ 5 ±0.15				

ECN NO.	REV.	DATE.	DESCRIPTION.	CHANGE.	CHECK.	APPRO.
	A		NEW			