

Ambient Light Sensor

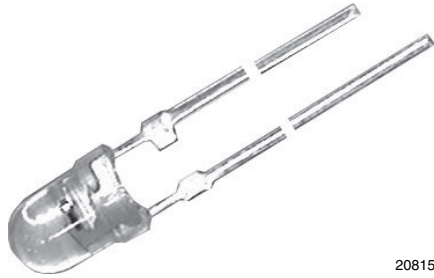

20815

FEATURES

- Package type: leaded
- Package form: T-1
- Dimensions (in mm): \varnothing 3
- High photo sensitivity
- Adapted to human eye responsivity
- Angle of half sensitivity: $\varphi = \pm 30^\circ$
- Material categorization:
for definitions of compliance please see www.vishay.com/doc?99912

RoHS
 COMPLIANT
 HALOGEN
FREE
GREEN
(5-2008)

DESCRIPTION

TEPT4400 ambient light sensor is a silicon NPN epitaxial planar phototransistor in a T-1 package. It is sensitive to visible light much like the human eye and has peak sensitivity at 570 nm.

APPLICATIONS

- Ambient light sensor for control of display backlight dimming in LCD displays and keypad backlighting of mobile devices and in industrial on / off-lighting operation
- Replacement of CdS photoresistors

PRODUCT SUMMARY

COMPONENT	I_{PCE} (μ A)	φ (deg)	$\lambda_{0.5}$ (nm)
TEPT4400	200	± 30	440 to 800

Note

- Test condition see table "Basic Characteristics"

ORDERING INFORMATION

ORDERING CODE	PACKAGING	REMARKS	PACKAGE FORM
TEPT4400	Bulk	MOQ: 5000 pcs, 1000 pcs/bulk. Label with I_{PCE} group on each bulk. Specifications of group A / B / C see table "Type Dedicated Characteristics" on page 2	T-1

Note

- MOQ: minimum order quantity

ABSOLUTE MAXIMUM RATINGS ($T_{amb} = 25^\circ\text{C}$, unless otherwise specified)

PARAMETER	TEST CONDITION	SYMBOL	VALUE	UNIT
Collector emitter voltage		V_{CEO}	6	V
Emitter collector voltage		V_{ECO}	1.5	V
Collector current		I_C	20	mA
Power dissipation	$T_{amb} \leq 55^\circ\text{C}$	P_V	100	mW
Junction temperature		T_j	100	$^\circ\text{C}$
Operating temperature range		T_{amb}	-40 to +85	$^\circ\text{C}$
Storage temperature range		T_{stg}	-40 to +100	$^\circ\text{C}$
Soldering temperature	$t \leq 3$ s	T_{sd}	260	$^\circ\text{C}$
Thermal resistance junction / ambient	JESTD 51	R_{thJA}	300	K/W

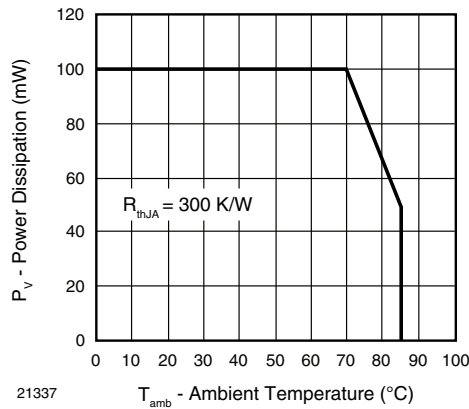

Fig. 1 - Power Dissipation Limit vs. Ambient Temperature

BASIC CHARACTERISTICS ($T_{amb} = 25\text{ }^{\circ}\text{C}$, unless otherwise specified)						
PARAMETER	TEST CONDITION	SYMBOL	MIN.	TYP.	MAX.	UNIT
Collector emitter breakdown voltage	$I_C = 0.1\text{ mA}$	V_{CEO}	6	-	-	V
Collector dark current	$V_{CE} = 5\text{ V}, E = 0$	I_{CEO}	-	3	50	nA
Collector emitter capacitance	$V_{CE} = 0\text{ V}, f = 1\text{ MHz}, E = 0$	C_{CEO}	-	16	-	pF
Collector light current	$E_v = 20\text{ lx}$, CIE illuminant A, $V_{CE} = 5\text{ V}$	I_{PCE}	15	-	70	μA
	$E_v = 100\text{ lx}$, CIE illuminant A, $V_{CE} = 5\text{ V}$	I_{PCE}	-	200	-	μA
Angle of half sensitivity		φ	-	± 30	-	deg
Wavelength of peak sensitivity		λ_p	-	570	-	nm
Range of spectral bandwidth		$\lambda_{0.5}$	-	440 to 800	-	nm
Collector emitter saturation voltage	$E_v = 20\text{ lx}$, CIE illuminant A, $I_{PCE} = 1.2\text{ }\mu\text{A}$	V_{CEsat}	-	0.1	-	V

TYPE DEDICATED CHARACTERISTICS						
PARAMETER	TEST CONDITION	BINNED GROUP	SYMBOL	MIN.	MAX.	UNIT
Photo current	$E_v = 20\text{ lx}$, CIE illuminant A, $V_{CE} = 5\text{ V}, T_{amb} = 25\text{ }^{\circ}\text{C}$	A	I_{PCE}	15	28.4	μA
		B	I_{PCE}	23.5	44.6	μA
		C	I_{PCE}	36.9	70	μA

Note

- Each 5000 piece bag will contain a single group. The label on the bag will indicate which binned group is in the bag. A specific group cannot be ordered. Production shipments containing multiple bags will likely include multiple groups. Please design accordingly.

BASIC CHARACTERISTICS ($T_{amb} = 25\text{ }^{\circ}\text{C}$, unless otherwise specified)

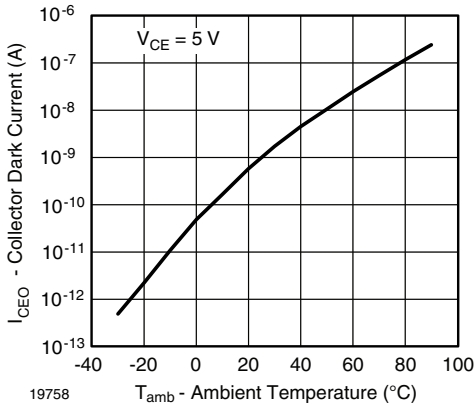

Fig. 2 - Collector Dark Current vs. Ambient Temperature

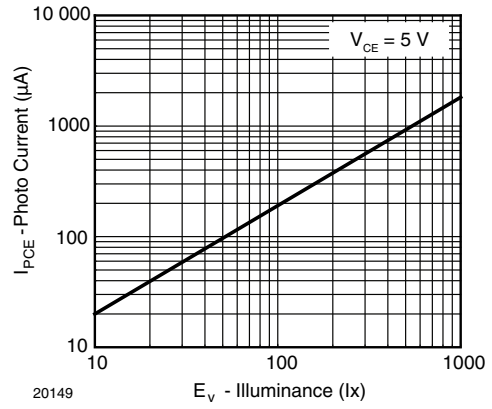

Fig. 5 - Photo Current vs. Illuminance

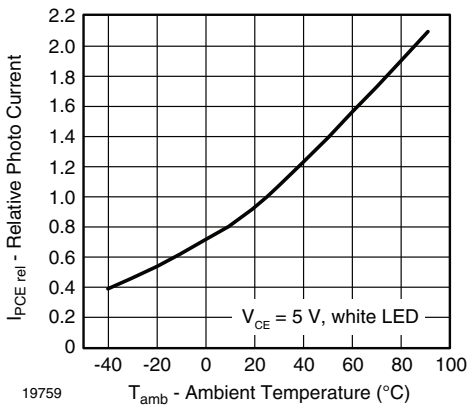

Fig. 3 - Relative Photo Current vs. Ambient Temperature

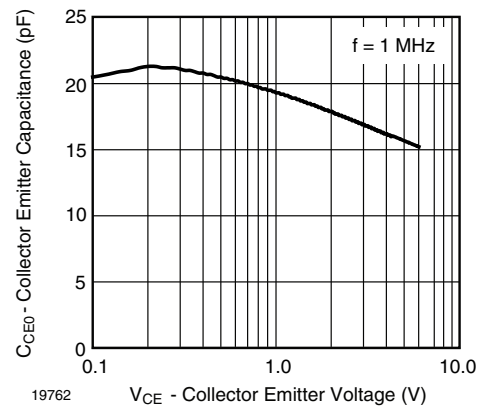

Fig. 6 - Collector Emitter Capacitance vs. Collector Emitter Voltage

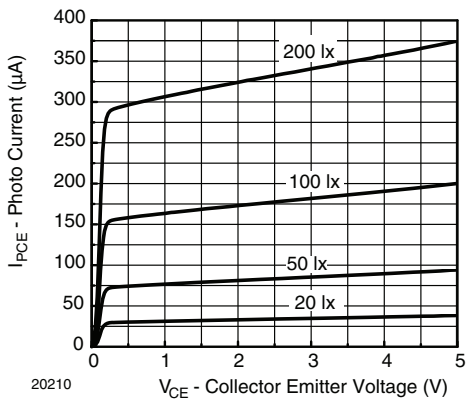

Fig. 4 - Photo Current vs. Collector Emitter Voltage

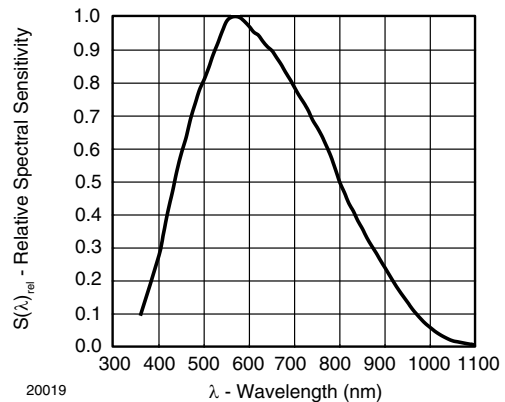

Fig. 7 - Relative Spectral Sensitivity vs. Wavelength

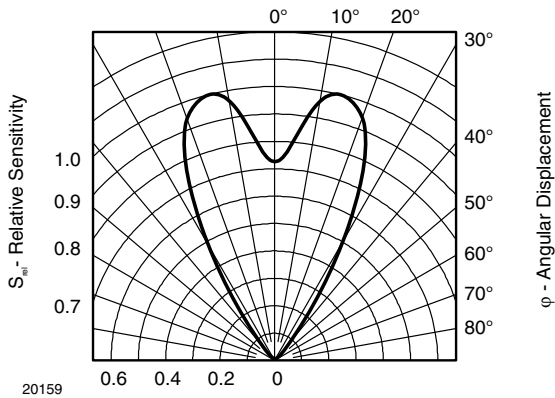
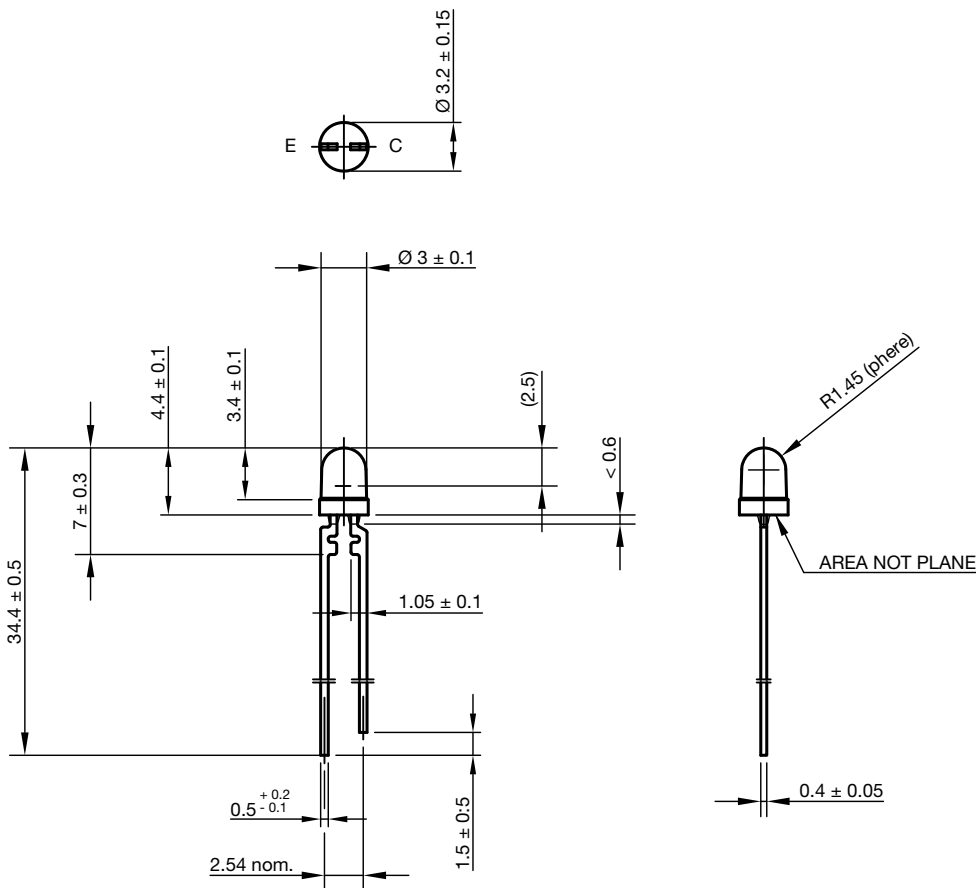
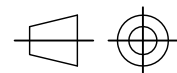

Fig. 8 - Relative Radiant Sensitivity vs. Angular Displacement

PACKAGE DIMENSIONS in millimeters



Drawing-No.: 6.544-5054.01-4
Issue: 5; 28.07.14



technical drawings according to DIN specifications



Disclaimer

ALL PRODUCT, PRODUCT SPECIFICATIONS AND DATA ARE SUBJECT TO CHANGE WITHOUT NOTICE TO IMPROVE RELIABILITY, FUNCTION OR DESIGN OR OTHERWISE.

Vishay Intertechnology, Inc., its affiliates, agents, and employees, and all persons acting on its or their behalf (collectively, "Vishay"), disclaim any and all liability for any errors, inaccuracies or incompleteness contained in any datasheet or in any other disclosure relating to any product.

Vishay makes no warranty, representation or guarantee regarding the suitability of the products for any particular purpose or the continuing production of any product. To the maximum extent permitted by applicable law, Vishay disclaims (i) any and all liability arising out of the application or use of any product, (ii) any and all liability, including without limitation special, consequential or incidental damages, and (iii) any and all implied warranties, including warranties of fitness for particular purpose, non-infringement and merchantability.

Statements regarding the suitability of products for certain types of applications are based on Vishay's knowledge of typical requirements that are often placed on Vishay products in generic applications. Such statements are not binding statements about the suitability of products for a particular application. It is the customer's responsibility to validate that a particular product with the properties described in the product specification is suitable for use in a particular application. Parameters provided in datasheets and / or specifications may vary in different applications and performance may vary over time. All operating parameters, including typical parameters, must be validated for each customer application by the customer's technical experts. Product specifications do not expand or otherwise modify Vishay's terms and conditions of purchase, including but not limited to the warranty expressed therein.

Except as expressly indicated in writing, Vishay products are not designed for use in medical, life-saving, or life-sustaining applications or for any other application in which the failure of the Vishay product could result in personal injury or death. Customers using or selling Vishay products not expressly indicated for use in such applications do so at their own risk. Please contact authorized Vishay personnel to obtain written terms and conditions regarding products designed for such applications.

No license, express or implied, by estoppel or otherwise, to any intellectual property rights is granted by this document or by any conduct of Vishay. Product names and markings noted herein may be trademarks of their respective owners.