

REFERENCE

SHARP
OPTO-ELECTRONIC DEVICES DIVISION
ELECTRONIC COMPONENTS GROUP
SHARP CORPORATION
SPECIFICATION

DEVICE SPECIFICATION FOR
PHOTOCOUPLER
MODEL No. PC817

Business dealing name

	PC817XNNSZW
	PC817X1NSZW
	PC817X2NSZW
	PC817X3NSZW
	PC817X5NSZW
	PC817X6NSZW
	PC817X8NSZW

Specified for _____

Enclosed please find copies of the Specifications which consists of 11 pages including cover.
After confirmation of the contents, please be sure to send back copies of the Specifications
with approving signature on each.

CUSTOMER'S APPROVAL

DATE _____

BY _____

PRESENTED

DATE _____

BY K.M

K. Hachimura,
Department General Manager of
Engineering Dept.,II
Opto-Electronic Devices Div.
ELECOM Group
SHARP CORPORATION

Product name : PHOTOCOUPLER

Model No. : PC817

Business dealing name

PC817XNNSZW
PC817X1NSZW
PC817X2NSZW
PC817X3NSZW
PC817X5NSZW
PC817X6NSZW
PC817X8NSZW

REFERENCE

1. These specification sheets include materials protected under copyright of Sharp Corporation ("Sharp"). Please do not reproduce or cause anyone to reproduce them without Sharp's consent.
2. When using this product, please observe the absolute maximum ratings and the instructions for use outlined in these specification sheets, as well as the precautions mentioned below. Sharp assumes no responsibility for any damage resulting from use of the product which does not comply with the absolute maximum ratings and the instructions included in these specification sheets, and the precautions mentioned below.

(Precautions)

- (1) This product is designed for use in the following application areas ;

(· OA equipment Audio visual equipment · Home appliances
· Telecommunication equipment (Terminal) · Measuring equipment
· Tooling machines · Computers)

If the use of the product in the above application areas is for equipment listed in paragraphs (2) or (3), please be sure to observe the precautions given in those respective paragraphs.

- (2) Appropriate measures, such as fail-safe design and redundant design considering the safety design of the overall system and equipment, should be taken to ensure reliability and safety when this product is used for equipment which demands high reliability and safety in function and precision, such as ;

(· Transportation control and safety equipment (aircraft, train, automobile etc.)
· Traffic signals · Gas leakage sensor breakers · Rescue and security equipment
· Other safety equipment etc.)

- (3) Please do not use this product for equipment which require extremely high reliability and safety in function and precision, such as ;

(· Space equipment · Telecommunication equipment (for trunk lines)
· Nuclear power control equipment · Medical equipment etc.)

- (4) Please contact and consult with a Sharp sales representative if there are any questions regarding interpretation of the above three paragraphs.

3. Please contact and consult with a Sharp sales representative for any questions about this product.

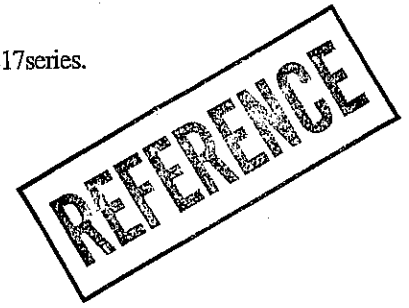

1. Application

This specification applies to the outline and characteristics of photocoupler Model No. PC817series.

- 2. Outline Refer to the attached sheet, page 3.
- 3. Ratings and characteristics Refer to the attached sheet, page 4, 5.
- 4. Reliability Refer to the attached sheet, page 6.
- 5. Outgoing inspection Refer to the attached sheet, page 7.
- 6. Supplement

6.1 Isolation voltage shall be measured in the following method.

- (1) Short between anode to cathode on the primary side and between collector to emitter on the secondary side.
- (2) The dielectric withstand tester with zero-cross circuit shall be used.
- (3) The wave form of applied voltage shall be a sine wave.

(It is recommended that the isolation voltage be measured in insulation oil.)

6.2 Package specifications Refer to the attached sheet, page 8, 9.

6.3 Business dealing name ("O" mark indicates business dealing name of ordered product)

Ordered product	Business dealing name	Rank mark	Ic (mA)
	PC817XNNSZW	A, B, C, or no mark	2.5 to 30
	PC817X1NSZW	A	4.0 to 8.0
	PC817X2NSZW	B	6.5 to 13
	PC817X3NSZW	C	10 to 20
	PC817X5NSZW	A or B	4.0 to 13
	PC817X6NSZW	B or C	6.5 to 20
	PC817X8NSZW	A, B or C	4.0 to 20

Test conditions
I _F =5mA V _{CE} =5V T _a =25°C

6.4 This Model is under application by UL.

6.5 This product is not designed against irradiation.

This product is assembled with electrical input and output.
 This product incorporates non-coherent light emitting diode.

6.6 ODS materials

This product shall not contain the following materials.

Also, the following materials shall not be used in the production process for this product.

Materials for ODS : CFC_s, Halon, Carbon tetrachloride, 1,1,1-Trichloroethane (Methylchloroform)

6.7 Brominated flame retardants

Specific brominated flame retardants such as the PBBO_s and PBB_s are not used in this device at all.

7. Notes

Precautions for Photocouplers

Refer to the attachment-1.

2. Outline

REFERENCE

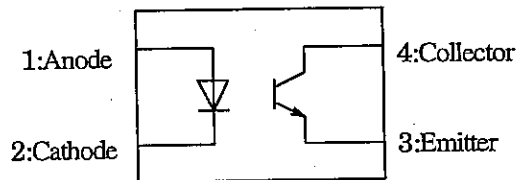
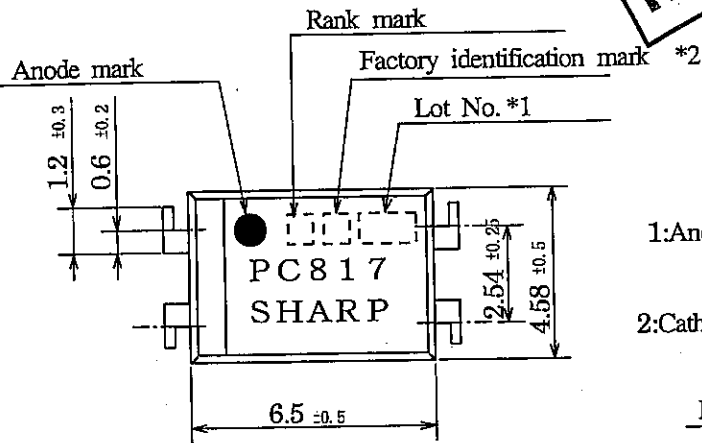

Pin Nos. and internal connection diagram

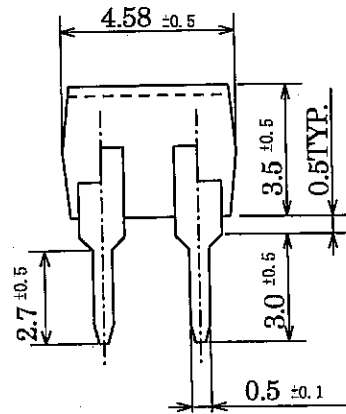
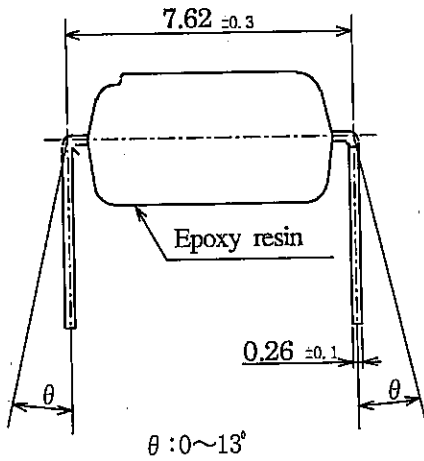

Product mass : Approx. 0.21g

- *1) 2-digit number shall be marked according to DIN standard.
- *2) Factory identification mark shall be or shall not be marked.
- *3) Marking is laser marking
- *4) Pin material : Copper Alloy
Pin finish : Pd plating

UNIT : 1/1 mm	
Name	PC817 Outline Dimensions (Business dealing name : PC817XNNSZW)

REFERENCE

3. Ratings and characteristics

3.1 Absolute maximum ratings

Ta=25°C

Parameter		Symbol	Rating	Unit
Input	*1 Forward current	I_F	50	mA
	*2 Peak forward current	I_{FM}	1	A
	Reverse voltage	V_R	6	V
	*1 Power dissipation	P	70	mW
Output	Collector-emitter voltage	V_{CEO}	80	V
	Emitter-collector voltage	V_{ECO}	6	V
	Collector current	I_C	50	mA
	*1 Collector power dissipation	P_C	150	mW
*1 Total power dissipation	P_{tot}	200	mW	
Operating temperature		T_{opr}	-30 to +100	°C
Storage temperature		T_{stg}	-55 to +125	°C
*3 Isolation voltage	$V_{iso}(rms)$	5	kV	
*4 Soldering temperature	T_{sol}	270	°C	

*1 The derating factors of absolute maximum ratings due to ambient temperature are shown in Fig. 1 to 4.

*2 Pulse width $\leq 100 \mu s$, Duty ratio : 0.001 (Refer to Fig. 5)

*3 AC for 1 min, 40 to 60%RH

*4 For 10 s

3.2 Electro-optical characteristics

Ta=25°C

Parameter		Symbol	Condition	MIN.	TYP.	MAX.	Unit
Input	Forward voltage	V_F	$I_F=20mA$	-	1.2	1.4	V
	Peak forward voltage	V_{FM}	$I_{FM}=0.5A$	-	-	3.0	V
	Reverse current	I_R	$V_R=4V$	-	-	10	μA
	Terminal capacitance	C_t	$V=0, f=1kHz$	-	30	250	pF
Output	Dark current	I_{CEO}	$V_{CE}=50V, I_F=0$	-	-	100	nA
	Collector-emitter breakdown voltage	BV_{CEO}	$I_C=0.1mA, I_F=0$	80	-	-	V
	Emitter-collector breakdown voltage	BV_{ECO}	$I_F=10 \mu A, I_C=0$	6	-	-	V
Transfer characteristics	Collector current	I_C	$I_F=5mA, V_{CE}=5V$	2.5	-	30	mA
	Collector-emitter saturation voltage	$V_{CE(sat)}$	$I_F=20mA, I_C=1mA$	-	0.1	0.2	V
	Isolation resistance	R_{ISO}	DC500V 40 to 60%RH	5×10^{10}	10^{11}	-	Ω
	Floating capacitance	C_f	$V=0, f=1MHz$	-	0.6	1.0	pF
	Cut-off frequency	f_c	$V_{CE}=5V, I_C=2mA$ $R_L=100 \Omega, -3dB$	-	80	-	kHz
	Rise time	t_r	$V_{CE}=2V, I_C=2mA$	-	4	18	μs
Fall time	t_f	$R_L=100 \Omega$	-	3	18	μs	

REFERENCE

(Fig. 1) Forward current vs. ambient temperature

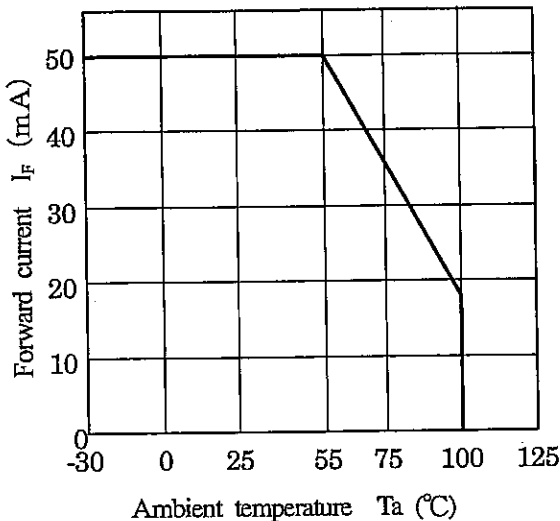

(Fig. 2) Diode power dissipation vs. ambient temperature

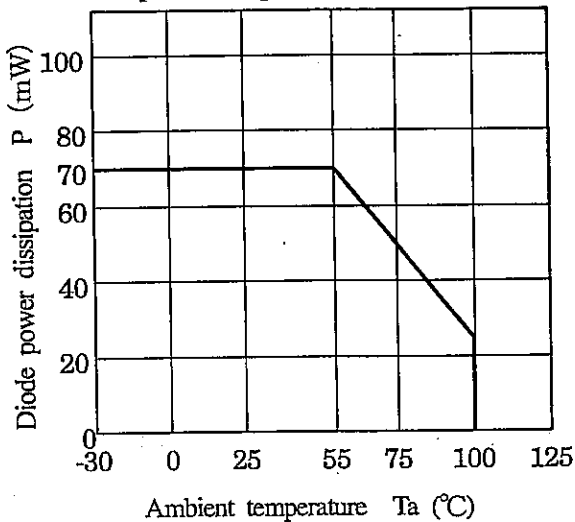

(Fig. 3) Collector power dissipation vs. ambient temperature

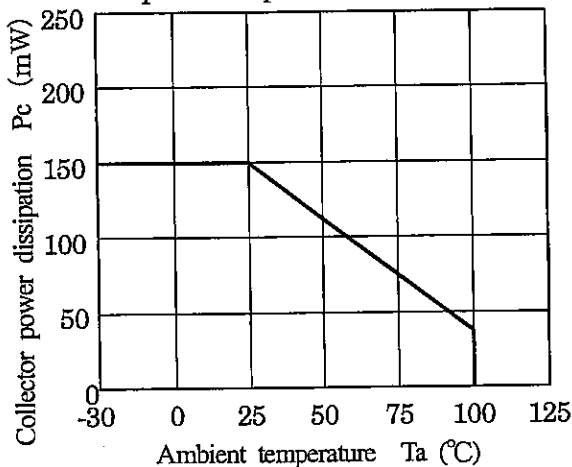

(Fig. 4) Total power dissipation vs. ambient temperature

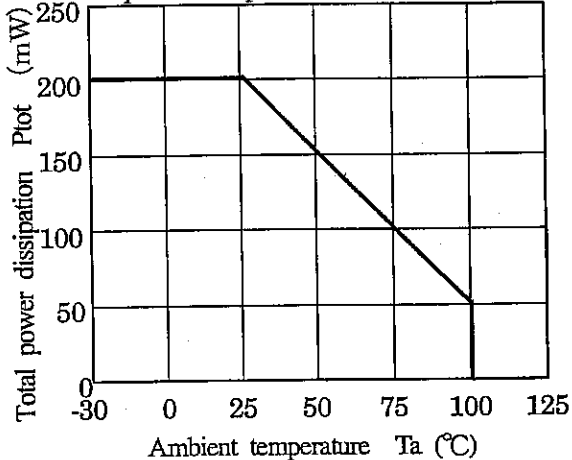

(Fig. 5) Peak forward current vs. duty ratio

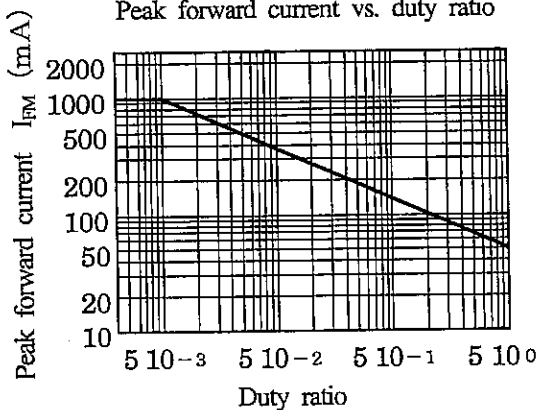

Pulse width $\leq 100\mu s$
 $T_a = 25^\circ C$

REFERENCE

4. Reliability

The reliability of products shall satisfy items listed below.

Confidence level : 90%

LTPD : 10 or 20

Test Items	Condition	Failure Judgement Criteria	Samples (n) Defective (C)
Solderability *2	245±3°C, 3s	-	n=11, C=0
Soldering heat	(Flow soldering) 270°C, 10 s	$V_F > U \times 1.2$ $I_R > U \times 2$ $I_{CBO} > U \times 2$ $I_C < L \times 0.7$ $V_{CE(sat)} > U \times 1.2$	n=11, C=0
	(Soldering by hand) 400°C, 3 s		n=11, C=0
Terminal strength (Tension)	Weight: 5N 5 s/each terminal		n=11, C=0
Terminal strength (Bending) *3	Weight: 2.5N 2 times/each terminal		n=11, C=0
Mechanical shock	15km/s ² , 0.5ms 3 times/±X, ±Y, ±Z direction		n=11, C=0
Variable frequency vibration	100 to 2000 to 100Hz/4 min 200m/s ² 4 times/X, Y, Z direction		n=11, C=0
Temperature cycling	1 cycle -55 °C to +125 °C (30 min) (30 min) 20 cycles test		U: Upper specification limit L: Lower specification limit n=22, C=0
High temp. and high Humidity storage	+60, 90H, 1000h		n=22, C=0
High temp. storage	+125 °C, 1000h		n=22, C=0
Low temp. storage	-55 °C, 1000h		n=22, C=0
Operation life	$I_F=50mA$, $P_{tot}=200mW$ $T_a=25 °C$, 1000h		n=22, C=0

*1 Test method, conforms to EIAJ ED 4701.

*2 Solder shall adhere at the area of 95% or more of immersed portion of lead, and pin hole or other holes shall not be concentrated on one portion.

*3 Terminal bending direction is shown below.

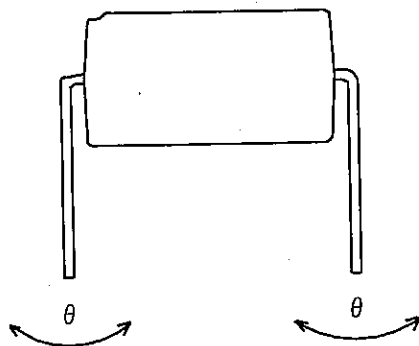

REFERENCE

5. Outgoing inspection

5.1 Inspection items

- (1) Electrical characteristics

$V_F, I_R, I_{CEO}, V_{CE(sat)}, I_C, R_{ISO}, V_{ISO}$

- (2) Appearance

5.2 Sampling method and Inspection level

A single sampling plan, normal inspection level II based on ISO 2859 is applied.

The AQL according to the inspection items are shown below.

Defect	Inspection item	AQL (%)
Major defect	Electrical characteristics Unreadable marking	0.065
Minor defect	Appearance defect except the above mentioned.	0.25

REFERENCE

6.2 Package specification

6.2.1 Package materials

No.	Name	Materials	Purposes
1	Sleeve	HIPS with preventing static electricity	Products packaged
2	Stopper	Styrene-Elastomer	Products fixed
3	Packing case	Corrugated cardboard	Sleeve packaged
4	Kraft tape	Paper	Lid of packaged case fixed
5	Label	Paper	Model No., quantity, inspection date and lot No. specified

6.2.2 Package method

- (1) MAX. 100pcs. of products shall be packaged in a sleeve and both of sleeve edges shall be fixed by stoppers.
- (2) MAX. 20 sleeves above shall be packaged in a packing case and pack a sheet of cushion at one side.
- (3) Model No., quantity, inspection date and lot No. shall be marked on the label and this label shall be put on the side of the packaging case.
- (4) Case shall be closed with the lid and enclosed with kraft tape.

6.2.3 Sleeve outline dimensions

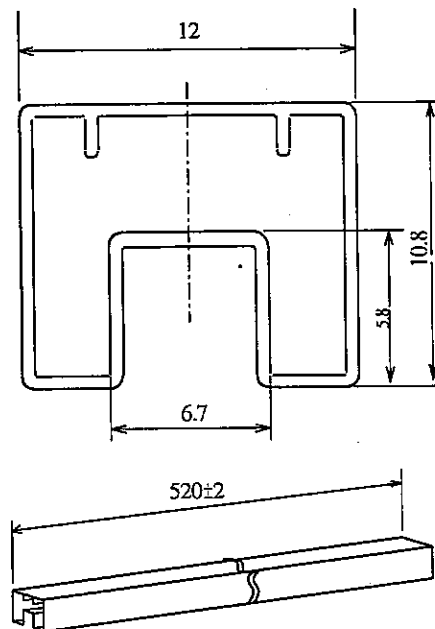

- Note
- 1) Thickness : 0.5 ± 0.2 mm
 - 2) Outer R: 0.5mm
 - 3) Process with applying antistatic treatment.
 - 4) Unless otherwise specified tolerances shall be ± 0.5 mm.
(However except for deformation due to the rubber stopper in sleeve.)

6.2.4 Packaging case outline dimensions

REFERENCE

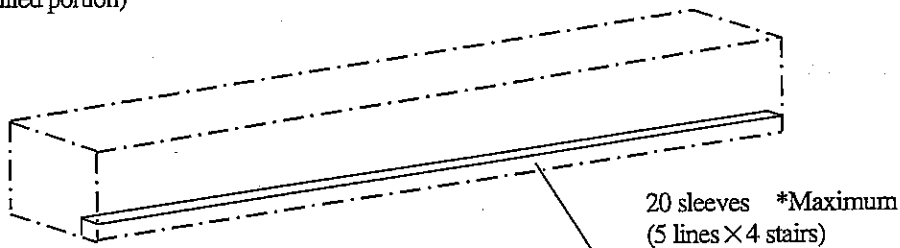
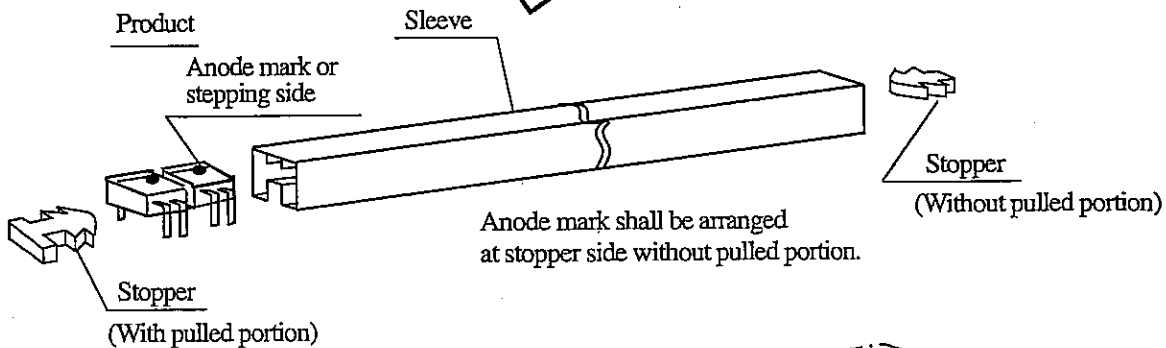

It is impossible to mix different model or different rank model in one case.

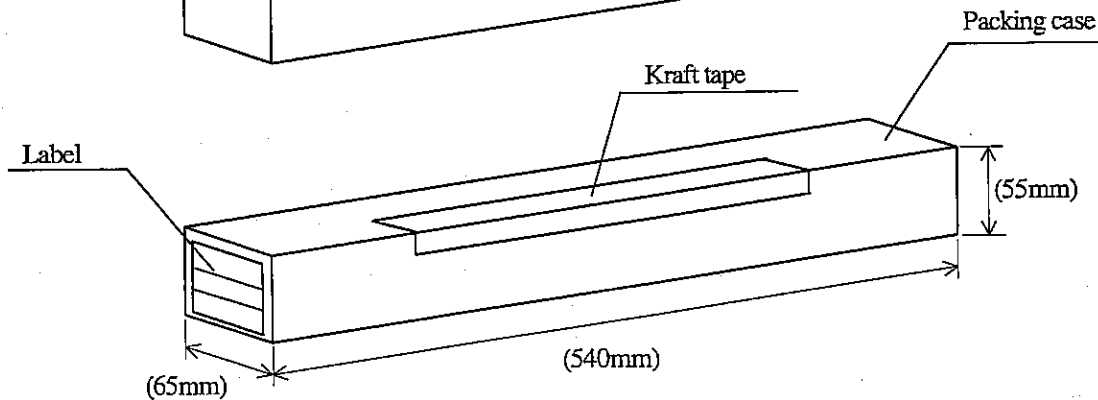
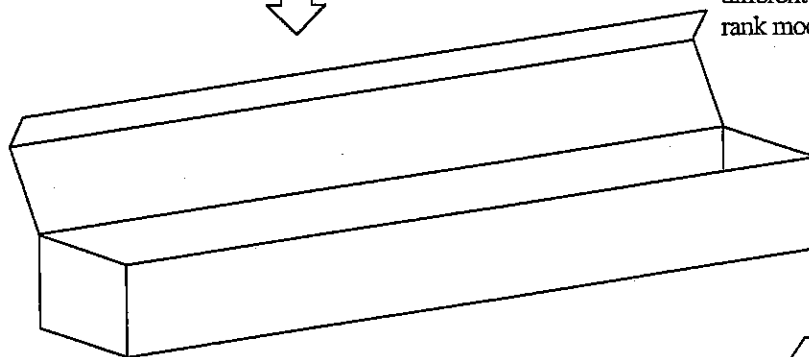

Regular packing mass : Approx. 860g

() : TYP. value

Precautions for Photocouplers

For cleaning

(1) Solvent cleaning : Solvent temperature 45°C or less
Immersion for 3 min or less

(2) Ultrasonic cleaning : The effect to device by ultrasonic cleaning differs by cleaning bath size, ultrasonic power output, cleaning time, PCB size or device mounting condition etc.
Please test it in actual using condition and confirm that doesn't occur any defect before starting the ultrasonic cleaning.

(3) Applicable solvent : Ethyl alcohol, Methyl alcohol, Isopropyl alcohol
In case when the other solvent is used, there are cases that the packaging resin is eroded.
Please use the other solvent after thorough confirmation is performed in actual using condition.

2. The LED used in the Photocoupler generally decreases the light emission power by operation.
In case of long operation time, please design the circuit with considering the degradation of the light emission power of the LED. (50%/5years)

3. There are cases that the deviation of the CTR and the degradation of the light emission power of the LED become big at IF is less than 1.0mA. Please design the circuit with considering this point.

4. Precautions for Soldering

(1) In case of flow solder (Whole dipping is possible)
It is recommended that flow solder should be at 270°C
and within 10 seconds (Pre-heating : 100 to 150°C, 30 to 80 seconds)

(2) It is recommended that hand soldering should be within $390 \pm 10^\circ\text{C}$ and within 3 seconds : Within 2 times

(3) Other notes
Depend on equipment and soldering conditions (temperature, Using solder etc.),
the effect to junction between PCB and lead pins of photocoupler is different.
Please confirm that there is no problem on the actual use conditions.

REFERENCE