

MESSRS: _____

AGENT: _____

**SPECIFICATION
of
PYROELECTRIC PASSIVE
INFRARED SENSOR**

MODEL NO. : P926M



APPROVED BY	CHECKED BY	DRAWN BY

MODEL NO: P926M	DRAWING NO.	REV: A	PAGE 1/7	 SHANGHAI NICERA SENSOR CO.,LTD.
PART NO:				

1. SCOPE

This specification describes a Pyroelectric Passive Infrared Sensor supplied by SHANGHAI NICERA SENSOR CO.,LTD. For passive infrared sensor device.

2. TYPE of SENSOR

- 2.1 TYPE NAME
Pyroelectric Passive Infrared Sensor
- 2.2 MODEL NO.
P926M

3. PHYSICAL CONFIGURATION AND DIMENSIONS

- 3.1. APPEARANCE
There are not remarkable wounds,spots,rust and etc.
- 3.2. DIMENSIONS
TO-5 Package : See Fig.1.
- 3.3 MARKING
Lot number and model number are marked on top surface of Detector.(Figure.1)

4. GENERAL CHARACTERISTICS

Table.1

PARAMETER		SPECIFICATION
4.1	Pyroelectric Passive Infrared Sensor	Balanced differential type (Series opposed type)
4.2	Circuit Configuration	See Fig.3

5. ELECTRICAL CHARACTERISTICS

(ENVIRONMENT TEMPERATURE=25(+/-) 5 DEG.C.)

Vdd=3.3V,unless specified.

Table.2

PARAMETER	CONDITION	SPECIFICATION
5.1	Maximum range(V)	-0.3 to 3.6V
5.2	Supply Voltage (V)	Single Power Supply 2.7 to 3.3V (maximum rating :3.6V)
5.3	Fluctuation in Supply Voltage	Single Power Supply Supply voltage (+/-) 3%
5.4	Current Consumption	Vdd=3.3V supply Circuit after Vout is not considered Non-Detection:20uAmax. Detection :20uAmax.
5.5	Vout Output Voltage	Single Power Supply *)Timing Chart : See Fig.2 Non-Detection: Max. 1.0 V Detection: Min. Vdd-1.0V
5.6	Warm-up time	*)Timing Chart : See Fig.2 Max. 30 sec.
5.7	Setting of ON TIME	*) Setting of ON TIME : See Fig.5 Input Voltage : 0V~VddV
5.8	Setting of detection performance	*) Setting of detection performance : See Fig.6 Input Voltage : 0V~VddV
5.9	OEN Input	VoutOutput ON:1.0V~VddV VoutOutput OFF:0 ~0.6V

MODEL NO: P926M	DRAWING NO.	REV:	PAGE	 SHANGHAI NICERA SENSOR CO.,LTD.
PART NO:		A	2/7	

6. OPTICAL CHARACTERISTICS

Table.3

PARAMETER		SPECIFICATION
6.1	Field of view	X-axis : 153 deg. Y-axis : 144 deg.
6.2	Filter substrate	Sillcon
6.3	Cut on (5%T ABS)	5 (+/-) 1 micron
6.4	Transmission	≥ 70% average 8 to 13 micron

7. ENVIROMENTAL REQUIREMENTS

Table.4

PARAMETER		SPECIFICATION
7.1	Operating Temperature	-20 to +70 deg. C
7.2	Storage Temperature	-30 to +80 deg. C
7.3	Relative Humidity	The Sensor shall operate without increase in Noise Output when exposed to 90 to 95% RH at 30 deg.C Continuously
7.4	Hermeticity	The Sensor shall be sealed to withsand a vacuum level of 21. 28kPa.

8. RoHS COMPLINCE

This product conforms to the RoHS Directive in force at the date of issuance of this Specification Sheet.

9. REVISION

Any revision of this specification should be made in writing by discussion

10. NOTES

10.1. Design restrictions/precautions

If used for outdoor applications, be sure to apply suitable supplementary optical filter, drip-proof and anti-dew construction. This sensor is designed for indoor use.

In cases where secondary accidents due to operation failure or malfunctions can be anticipated, add a fail safe function to the design.

10.2. Usage restrictions/precautions

To prevent sensor malfunctions, operational failure or any deterioration of its characteristics, do not use this sensor in the following, or similar, conditions.

MODEL NO: P926M	DRAWING NO.	REV:	PAGE	 SHANGHAI NICERA SENSOR CO.,LTD.
PART NO:		A	3/7	

- A. In rapid environmental temperature changes
- B. In strong shock or vibration.
- C. In a place where there are obstructing materials(Glass, Fog, etc) through which infrared rays cannot pass within detection area.
- D. In fluid, corrosive gases and sea breeze.
- E. Continual use in high humidity atmosphere.
- F. Exposed to direct sun light or headlights of automobiles.
- G. Exposed to direct wind from a heater or air conditioner.

10.3. Assembly restrictions/precautions

Soldering

- A. Use soldering irons when soldering .
- B. Avoid keeping pins of this sensor hot for a long time as excessive heat may cause deterioration of its quality.(Ex. Within 5 sec. at 350 deg.C)

Washing

- A. Be sure to wash out all flux after soldering as remainder may cause malfunctions.
- B. Use a brush when washing . Washing with an ultrasonic cleaner may cause operational failure.

10.4.Handling and storage restrictions/precautions

To prevent sensor malfunctions, operational failure, appearance damage or any deterioration of its characteristics, do not expose this sensor to the following or similar handing and storage conditions.

- A. Vibration for a long time.
- B. Strong shock
- C. Static electricity or strong electromagnetic waves.
- D. High or Low temperature and humidity for a long time.
- E. Corrosive gases or sea breeze.
- F. Dirty and dusty environments that may contaminate the optical lens.

10.5.Restrictions on product use

The product described in this document shall not be used or embedded to any downstream products of which manufacture, use and/ or sales are prohibited under any applicable laws and regulations.

Sensor troubles resulting from misuse, inappropriate handling or storage are not the manufacturer's responsibility.

In the infrared sensor product specifications as shown in the standard premise, Shanghai Nicera Sensor company reserves the right to part material change.

MODEL NO: P926B	DRAWING NO.	REV:	PAGE	 SHANGHAI NICERA SENSOR CO.,LTD.
PART NO:		A	4/7	

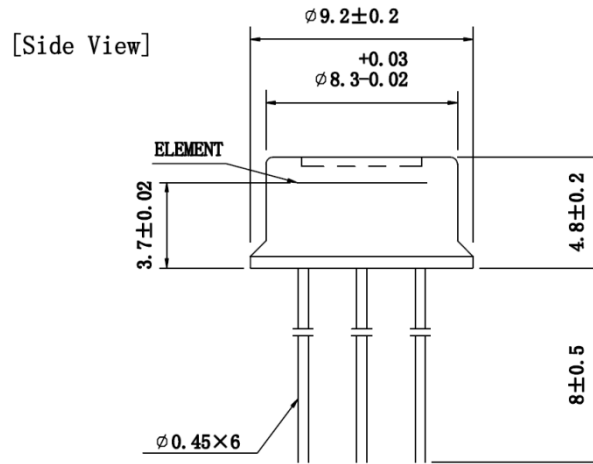
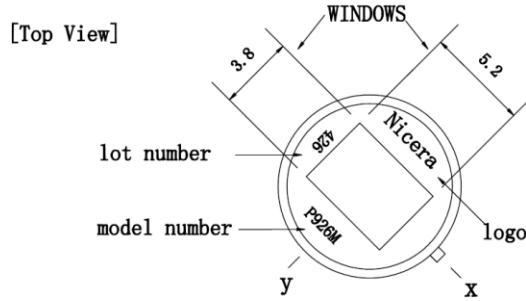
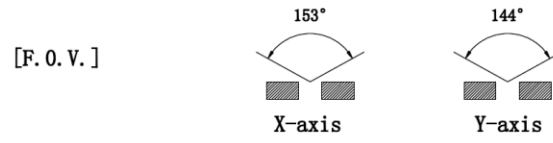

【Bottom View】

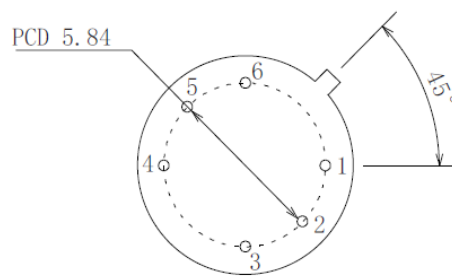

- 1 - OEN
- 2 - SENSE
- 3 - ONTIME
- 4 - Vout
- 5 - Ground
- 6 - VDD

Tolerance without instruction: (+ / -) 0.2
Unit : [mm]

(*)The sensor conforms to the standard for RoHS.

Fig.1 : Dimensions

MODEL NO: P926M	DRAWING NO.	REV:	PAGE	 SHANGHAI NICERA SENSOR CO.,LTD.
PART NO:		A	5/7	

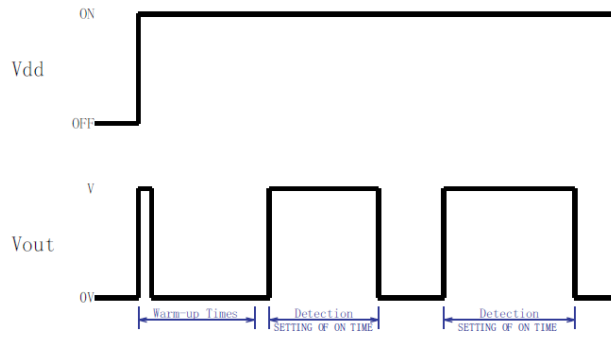

Cautions) Warm-up Time: Max. 30 sec.
Regarding of detection or non-detection during the waiting time, ON signal may be made due to Instability of circuit

Fig.2: Timing Chart

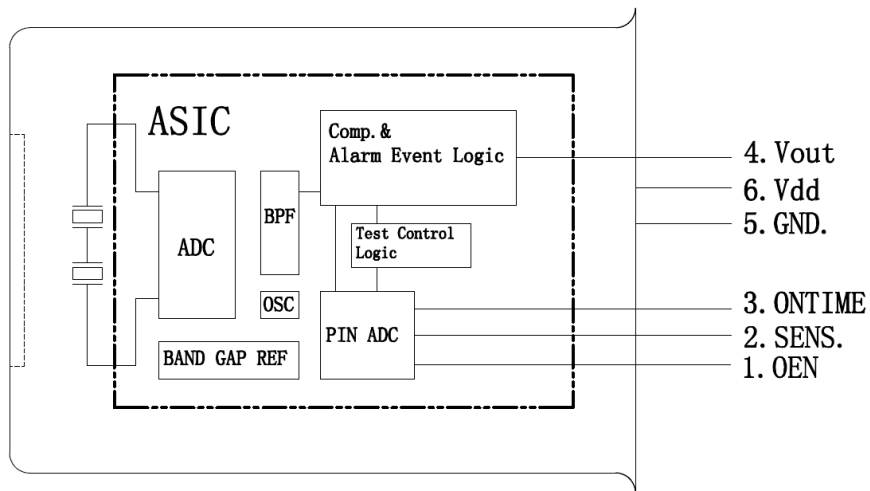

Fig.3: Circuit configuration

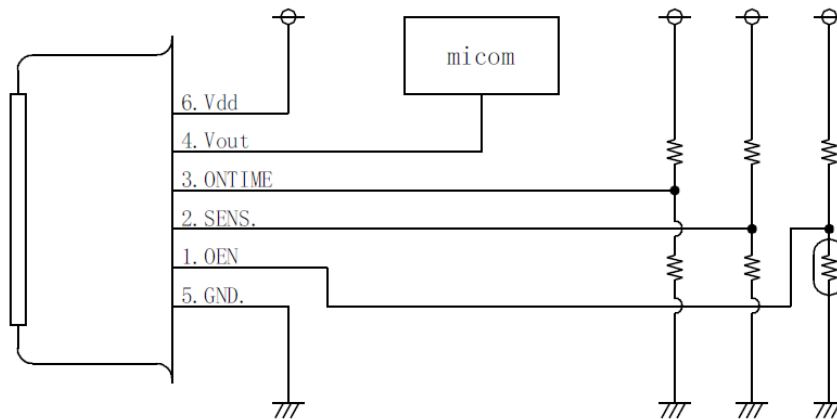



Fig.4: Basic Application Circuit Examples

MODEL NO: P926M	DRAWING NO.	REV: A	PAGE 6/7	 SHANGHAI NICERA SENSOR CO.,LTD.
PART NO:				

Pin voltage	ON Time
Vdd*1/128 or less	2 sec.
Vdd * 3 / 128	4 sec.
Vdd * 5 / 128	6 sec.
Vdd * 7 / 128	8 sec.
Vdd * 9 / 128	16 sec.
Vdd * 11 / 128	32 sec.
Vdd * 13 / 128	49 sec.
Vdd * 15 / 128	1 min. 5 sec.
Vdd * 17 / 128	2 min. 11 sec.
Vdd * 19 / 128	4 min. 22 sec.
Vdd * 21 / 128	6 min. 33 sec.
Vdd * 23 / 128	8 min. 44 sec.
Vdd * 25 / 128	17 min. 28 sec.
Vdd * 27 / 128	34 min. 57 sec.
Vdd * 29 / 128	52 min. 25 sec.
Vdd * 31 / 128 or above	1 hour 10 min.

Fig.5 : Setting of ON TIME

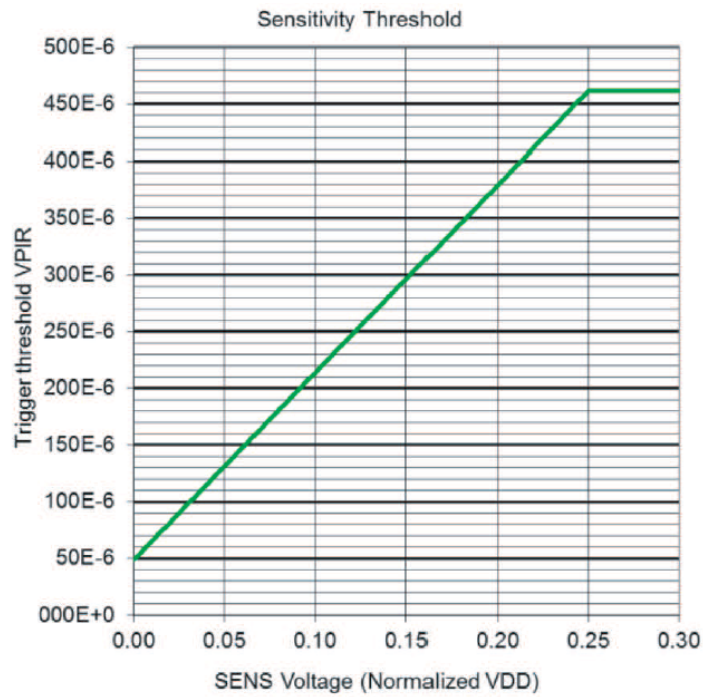



Fig.6 : Setting of detection performance

MODEL NO: P926M	DRAWING NO.	REV: A	PAGE 7/7	 SHANGHAI NICERA SENSOR CO.,LTD.
PART NO:				