

P4KE SERIES

List

List..... 1

Package outline..... 2

Features..... 2

Mechanical data..... 2

Maximum ratings2

Electrical characteristics..... 3

Rating and characteristic curves..... 4

Pinning information..... 5

Taping & bulk specifications for AXIAL devices..... 5

Suggested thermal profiles for soldering processes..... 6

High reliability test capabilities.....7

P4KE SERIES

400W Axial Leaded Transient Voltage Suppressors - 6.8V-440V

Features

- Axial lead type devices for through hole design.
- 400W peak pulse power capability with a 10/1000us waveform, repetition rate (duty cycle): 0.01%.
- Excellent clamping capability.
- Low incremental surge resistance.
- Fast response time from 0V to VBR, typically less than 1 pS for uni-directional & 5 nS for bi-directional types.
- Ultra high-speed switching.
- Glass passivated chip junction.
- Lead-free parts meet environmental standards of MIL-STD-19500 /228
- Suffix "-H" indicates Halogen free parts, ex. P4KE6.8A-H

Mechanical data

- Epoxy : UL94-V0 rated flame retardant
- Case : Molded plastic, DO-41
- Lead : Axial leads, solderable per MIL-STD-202, Method 208 guaranteed
- Polarity: Color band denotes cathode end
- Mounting Position : Any
- Weight : Approximated 0.33 gram

Package outline

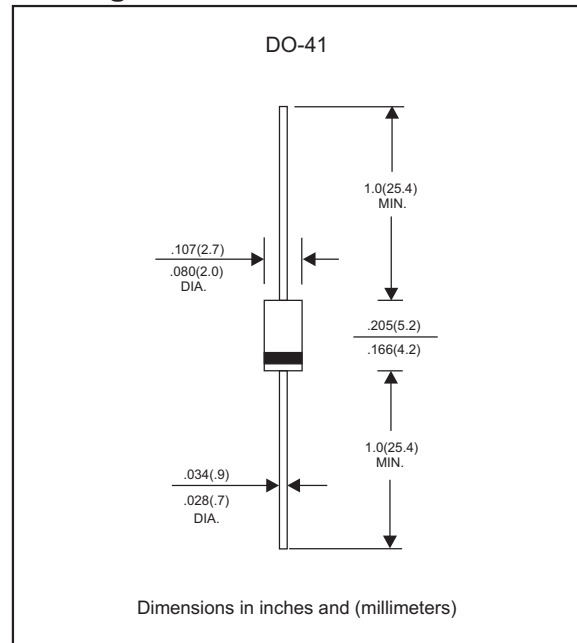

Maximum ratings (AT $T_A=25^\circ\text{C}$ unless otherwise noted)

PARAMETER	CONDITIONS	Symbol	MIN.	TYP.	MAX.	UNIT
Peak power dissipation	with a 10/1000us waveform, Note 1 & Fig. 1	P_{PPM}			400	W
Peak pulse current	with a 10/1000us waveform	I_{PPM}	See table 1			A
Steady state power dissipation	at $T_J=75^\circ\text{C}$ lead length 0.375" (9.5 mm)	$P_{M(AV)}$			1.0	W
Peak forward surge current	8.3ms single half sine-wave (JEDEC Method), note 2	I_{FSM}			40	A
Maximum instantaneous forward voltage	for uni-directional types only, at 25A, see note 3	V_F			3.5/5.0	V
Operating junction temperature range		T_J	-55		+150	$^\circ\text{C}$
Storage temperature range		T_{STG}	-55		+150	$^\circ\text{C}$

Note 1. Non-repetitive current pulse, per Fig. 3 and derated above $T_A=25^\circ\text{C}$ per Fig. 2

2. Measured on 8.3 ms single half sine-wave or equivalent square wave, duty cycle=4 pulses per minute maximum

3. $V_F < 3.5\text{V}$ for devices of $V_{BR} < 200\text{V}$, and $V_F < 5.0\text{V}$ for devices of $V_{BR} > 201\text{V}$

Electrical characteristics (at $T_A=25^\circ\text{C}$ unless otherwise noted)

Table 1

Part No. (Uni)	Part No. (Bi)	Reverse Stand-off Voltage	Breakdown Voltage @ I_T		Test Current	Maximum Clamping Voltage @ I_{PP}		Maximum Reverse Leakage Current	Marking Code	
		V_{RWM}	$V_{BR\ Min}$	$V_{BR\ Max}$	I_T	$V_c@I_{PP}$		$I_R@V_{RWM}$	Uni	Bi
		Volts	Volts	Volts	mA	Volts	$I_{PP}(A)$	$I_R(\mu A)$		
P4KE6.8A	P4KE6.8CA	5.80	6.45	7.14	10	10.5	38.0	1000	P4KE6.8A	P4KE6.8CA
P4KE7.5A	P4KE7.5CA	6.40	7.13	7.88	10	11.3	35.3	500	P4KE7.5A	P4KE7.5CA
P4KE8.2A	P4KE8.2CA	7.02	7.79	8.61	10	12.1	33.0	200	P4KE8.2A	P4KE8.2CA
P4KE9.1A	P4KE9.1CA	7.78	8.65	9.55	1.0	13.4	29.8	50	P4KE9.1A	P4KE9.1CA
P4KE10A	P4KE10CA	8.55	9.50	10.5	1.0	14.5	27.5	10	P4KE10A	P4KE10CA
P4KE11A	P4KE11CA	9.40	10.5	11.6	1.0	15.6	25.6	5	P4KE11A	P4KE11CA
P4KE12A	P4KE12CA	10.2	11.4	12.6	1.0	16.7	23.9	5	P4KE12A	P4KE12CA
P4KE13A	P4KE13CA	11.1	12.4	13.7	1.0	18.2	21.9	5	P4KE13A	P4KE13CA
P4KE15A	P4KE15CA	12.8	14.3	15.8	1.0	21.2	18.8	5	P4KE15A	P4KE15CA
P4KE16A	P4KE16CA	13.6	15.2	16.8	1.0	22.5	17.7	5	P4KE16A	P4KE16CA
P4KE18A	P4KE18CA	15.3	17.1	18.9	1.0	25.5	15.6	5	P4KE18A	P4KE18CA
P4KE20A	P4KE20CA	17.1	19.0	21.0	1.0	27.7	14.4	5	P4KE20A	P4KE20CA
P4KE22A	P4KE22CA	18.8	20.9	23.1	1.0	30.6	13.0	5	P4KE22A	P4KE22CA
P4KE24A	P4KE24CA	20.5	22.8	25.2	1.0	33.2	12.0	5	P4KE24A	P4KE24CA
P4KE27A	P4KE27CA	23.1	25.7	28.4	1.0	37.5	10.6	5	P4KE27A	P4KE27CA
P4KE30A	P4KE30CA	25.6	28.5	31.5	1.0	41.4	9.6	5	P4KE30A	P4KE30CA
P4KE33A	P4KE33CA	28.2	31.4	34.7	1.0	45.7	8.7	5	P4KE33A	P4KE33CA
P4KE36A	P4KE36CA	30.8	34.2	37.8	1.0	49.9	8.0	5	P4KE36A	P4KE36CA
P4KE39A	P4KE39CA	33.3	37.1	41.0	1.0	53.9	7.4	5	P4KE39A	P4KE39CA
P4KE43A	P4KE43CA	36.8	40.9	45.2	1.0	59.3	6.7	5	P4KE43A	P4KE43CA
P4KE47A	P4KE47CA	40.2	44.7	49.4	1.0	64.8	6.1	5	P4KE47A	P4KE47CA
P4KE51A	P4KE51CA	43.6	48.5	53.6	1.0	70.1	5.7	5	P4KE51A	P4KE51CA
P4KE56A	P4KE56CA	47.8	53.2	58.8	1.0	77.0	5.1	5	P4KE56A	P4KE56CA
P4KE62A	P4KE62CA	53.0	58.9	65.1	1.0	85.0	4.7	5	P4KE62A	P4KE62CA
P4KE68A	P4KE68CA	58.1	64.6	71.4	1.0	92.0	4.3	5	P4KE68A	P4KE68CA
P4KE75A	P4KE75CA	64.1	71.3	78.8	1.0	103.0	3.8	5	P4KE75A	P4KE75CA
P4KE82A	P4KE82CA	70.1	77.9	86.1	1.0	113.0	3.5	5	P4KE82A	P4KE82CA
P4KE91A	P4KE91CA	77.8	86.5	95.5	1.0	125.0	3.2	5	P4KE91A	P4KE91CA
P4KE100A	P4KE100CA	85.5	95.0	105.0	1.0	137.0	2.9	5	P4KE100A	P4KE100CA
P4KE110A	P4KE110CA	94.0	105.0	116.0	1.0	152.0	2.6	5	P4KE110A	P4KE110CA
P4KE120A	P4KE120CA	102.0	114.0	126.0	1.0	165.0	2.4	5	P4KE120A	P4KE120CA
P4KE130A	P4KE130CA	111.0	124.0	137.0	1.0	179.0	2.2	5	P4KE130A	P4KE130CA
P4KE150A	P4KE150CA	128.0	143.0	158.0	1.0	207.0	1.9	5	P4KE150A	P4KE150CA
P4KE160A	P4KE160CA	136.0	152.0	168.0	1.0	219.0	1.8	5	P4KE160A	P4KE160CA
P4KE170A	P4KE170CA	145.0	162.0	179.0	1.0	234.0	1.7	5	P4KE170A	P4KE170CA
P4KE180A	P4KE180CA	154.0	171.0	189.0	1.0	246.0	1.6	5	P4KE180A	P4KE180CA
P4KE200A	P4KE200CA	171.0	190.0	210.0	1.0	274.0	1.4	5	P4KE200A	P4KE200CA
P4KE220A	P4KE220CA	185.0	209.0	231.0	1.0	328.0	1.2	5	P4KE220A	P4KE220CA
P4KE250A	P4KE250CA	214.0	237.0	263.0	1.0	344.0	1.1	5	P4KE250A	P4KE250CA
P4KE300A	P4KE300CA	256.0	285.0	315.0	1.0	414.0	0.96	5	P4KE300A	P4KE300CA
P4KE350A	P4KE350CA	300.0	332.0	368.0	1.0	482.0	0.82	5	P4KE350A	P4KE350CA
P4KE400A	P4KE400CA	342.0	380.0	420.0	1.0	548.0	0.72	5	P4KE400A	P4KE400CA
P4KE440A	P4KE440CA	376.0	418.0	462.0	1.0	600.0	0.66	5	P4KE440A	P4KE440CA

- Note 1. V_{BR} measured after I_T applied for 300us, I_T =square wave pulse or equivalent
 2. Surge current waveform per Fig. 3 and derated per Fig. 2
 3. For bi-directional types having V_{RWM} of 10 volts and less, the I_R limit is doubled
 4. Suffix 'C' denotes bi-directional devices. Suffix 'A' denotes 5% tolerance devices, no suffix denotes 10% tolerance devices.
 5. All terms and symbols are consistent with ANS/IEEE C62.35



Rating and characteristic curves (P4KE SERIES)

Fig.1 - PEAK PULSE POWER RATING CURVE

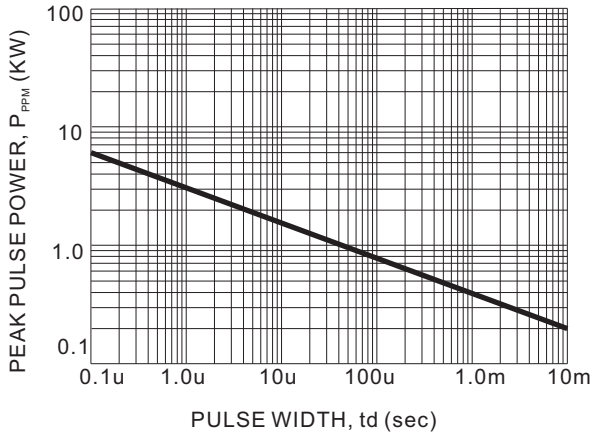

Fig.2 - PULSE DERATING CURVE

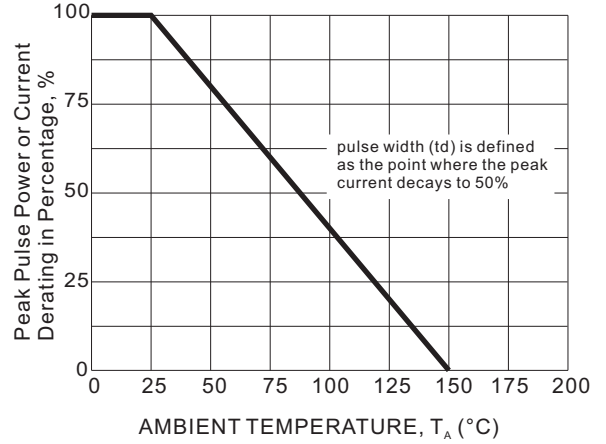

Fig.3 - Pulse Waveform

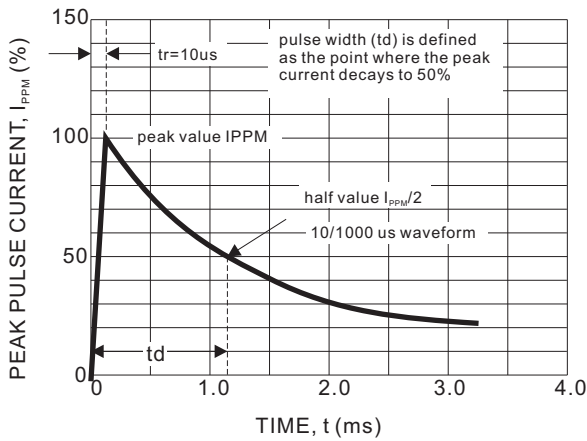

Fig.4 - Typical Junction Capacitance

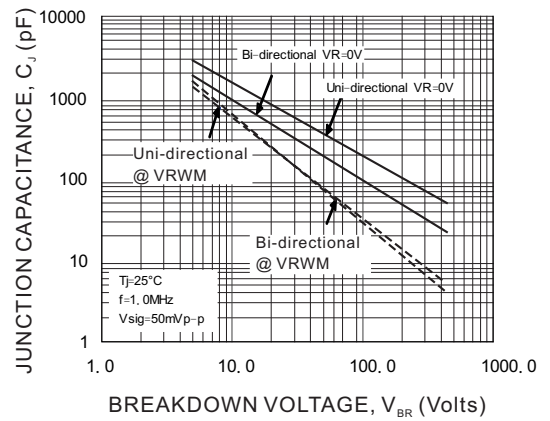

Fig.5 - STEADY STATE POWER DERATING CURVE

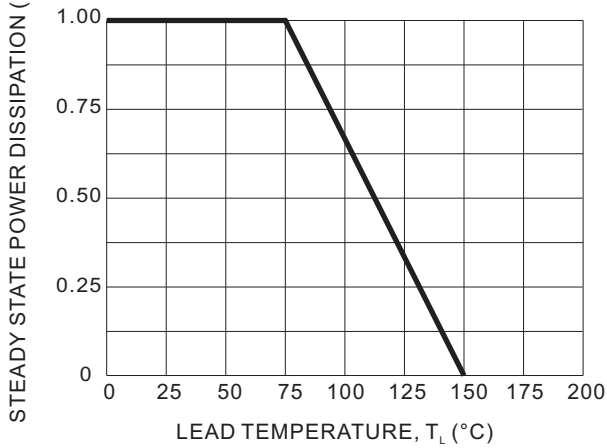
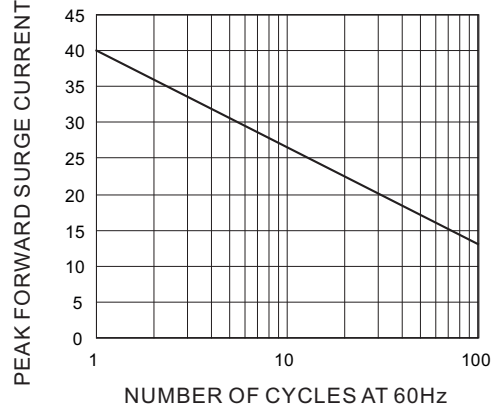





Fig.6 - MAXIMUM NON-REPETITIVE FORWARD SURGE CURRENT



P4KE SERIES

Pinning information

Pin	Simplified outline	Symbol
Uni-Directional Pin1 cathode Pin2 anode		
Bi-Directional		

Taping & bulk specifications for AXIAL devices

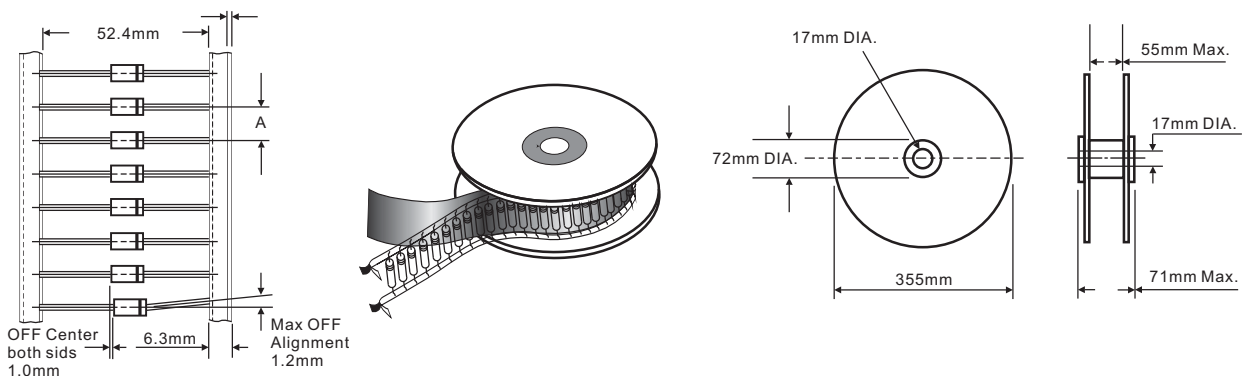

REEL PACKING

DEVICE CASE TYPE	Q'TY 1 (PCS / REEL)	COMPONENT SPACING "A" in FIG. A	CARTON SIZE (m/m)	Q'TY 2 (PCS / CARTON)	APPROX. CROSS WEIGHT(kg)
DO-41	5,000	5 mm	360 * 340 * 370	20,000	10.8

AMMO PACKING

DEVICE CASE TYPE	Q'TY 1 (PCS / BOX)	INNER BOX SIZE (m/m)	CARTON SIZE (m/m)	Q'TY 2 (PCS / CARTON)	APPROX. CROSS WEIGHT(kg)
DO-41	5,000	260 * 83 * 160	440 * 270 * 340	50,000	20.0

P4KE SERIES

BULK PACKING

DEVICE CASE TYPE	Q'TY 1 (PCS / BOX)	INNER BOX SIZE (m/m)	CARTON SIZE (m/m)	Q'TY 2 (PCS / CARTON)	APPROX. CROSS WEIGHT(kg)
DO-41	1,000	194 * 84 * 20	465 * 220 * 260	50,000	20.6

Suggested thermal profiles for soldering processes

1. Lead free temperature profile wave-soldering

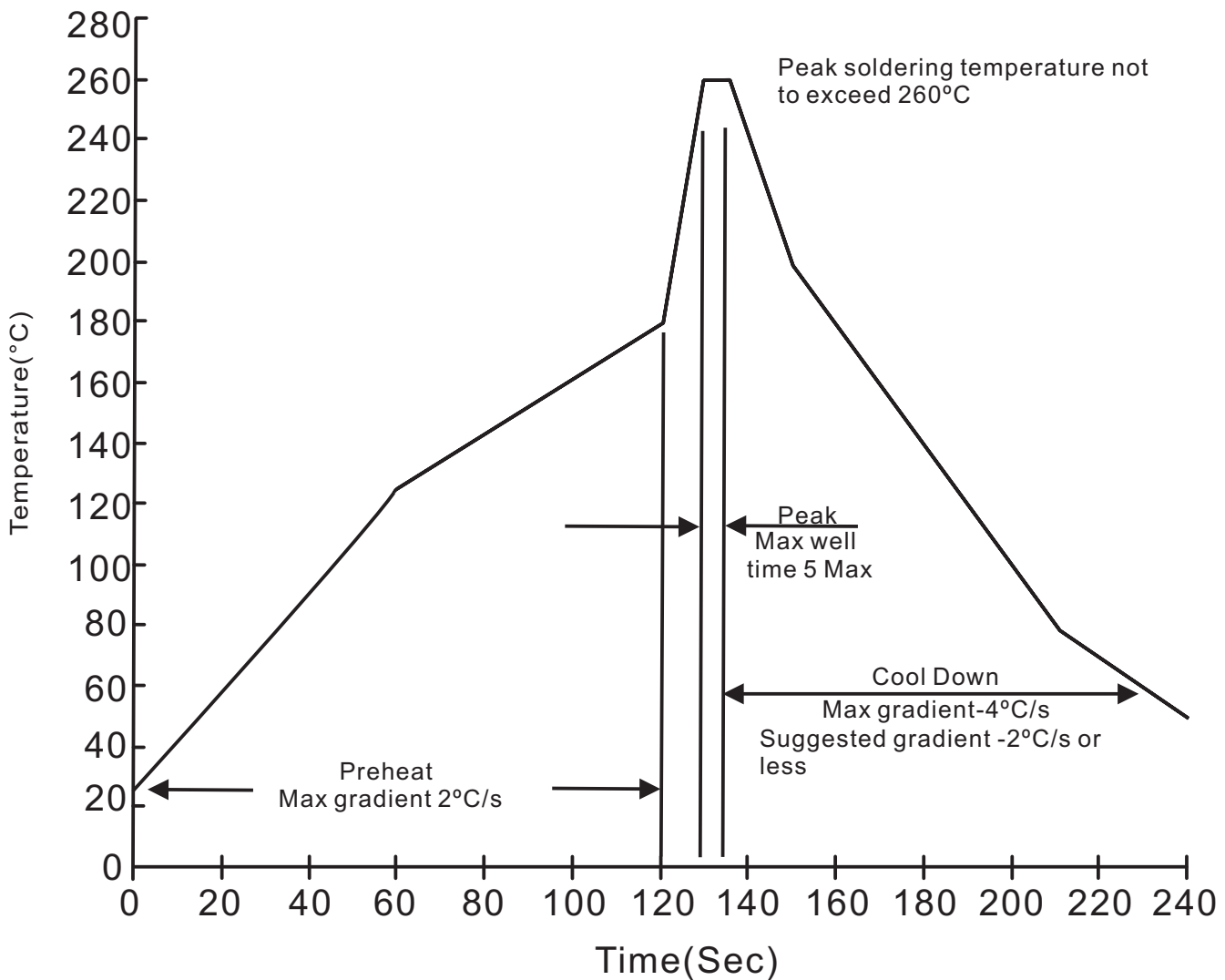

P4KE SERIES**High reliability test capabilities**

Item Test	Conditions	Reference
1. Solder Resistance	at 260±5°C for 10±2sec. immerse body into solder 1/16"±1/32"	MIL-STD-750D METHOD-2031
2. Solderability	at 245±5°C for 5 sec.	MIL-STD-202F METHOD-208
3. Pull Test	1.0kg in axial lead direction for 10 sec.	MIL-STD-750D METHOD-2036
4. Bend Lead	1.0kg weight applied to each lead bending arc 90°±5° for 3 times.	MIL-STD-750D METHOD-2036
5. High Temperature Reverse Bias	$V_{BR}=V_{BR}$ Nom. 80% at $T_J=150^\circ\text{C}$ for 168 hrs.	MIL-STD-750D METHOD-1038
8. Pressure Cooker	15P _{SIG} at $T_A=121^\circ\text{C}$ for 4 hrs.	JESD22-A102
7. Temperature Cycling	-55°C to +125°C dwelled for 30 min. and transferred for 5min. total 10 cycles.	MIL-STD-750D METHOD-1051
8. Humidity	at $T_A=85^\circ\text{C}$, RH=85% for 1000hrs.	MIL-STD-750D METHOD-1021
9. High Temperature Storage Life	at 175°C for 1000 hrs.	MIL-STD-750D METHOD-1031