

LTVS16H5.0T5G

LTVS16H5.0T5G

Features

- 5V uni-directional ESD diode
- Low clamping voltage
- Complies with IEC 61000-4-2 standards:
 - Air discharge: $\pm 30\text{kV}$
 - Contact discharge: $\pm 30\text{kV}$
- RoHS Compliant

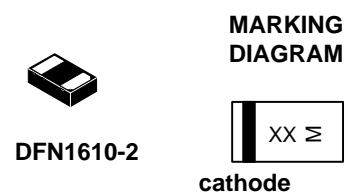

XX = Specific Device Code
M = Month Code

Ordering information

Device	Package	Shipping
LTVS16H5.0T5G	DFN1610	8000/Tape&Reel

Absolute Maximum Ratings ($T_A=25^\circ\text{C}$ unless otherwise specified)

Parameter	Symbol	Value	Unit
Peak Pulse Power (8/20 μs)	Ppk	1250	W
Peak Pulse Current (8/20 μs)	I _{PP}	100	A
Operating Temperature Range	T _J	-55 to +125	$^\circ\text{C}$
Storage Temperature Range	T _{stg}	-55 to +150	$^\circ\text{C}$

Electrical Characteristics ($T_A=25^\circ\text{C}$ unless otherwise specified)

Parameter	Symbol	Min	Typ	Max	Unit	Test Condition
Reverse Working Voltage	V _{RWM}			5	V	
Breakdown Voltage	V _{BR}	6		7.8	V	I _T = 1mA
Reverse Leakage Current	I _R			2	μA	V _R = 5V
Clamping Voltage	V _C			8.5	V	I _{PP} = 10A (8 x 20 μs pulse)
Clamping Voltage	V _C			15	V	I _{PP} = 80A (8 x 20 μs pulse)
Junction Capacitance	C _J			800	pF	V _R = 0V, f = 1MHz

Note: Electrical parameters are only for die, performance may alter after assembly.

LTVS16H5.0T5G

Typical Performance Characteristics (T_A=25°C unless otherwise Specified)

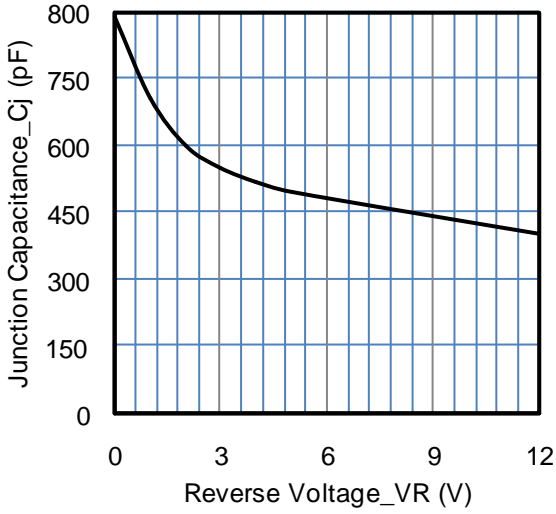

Fig1. Junction Capacitance vs. Reverse Voltage

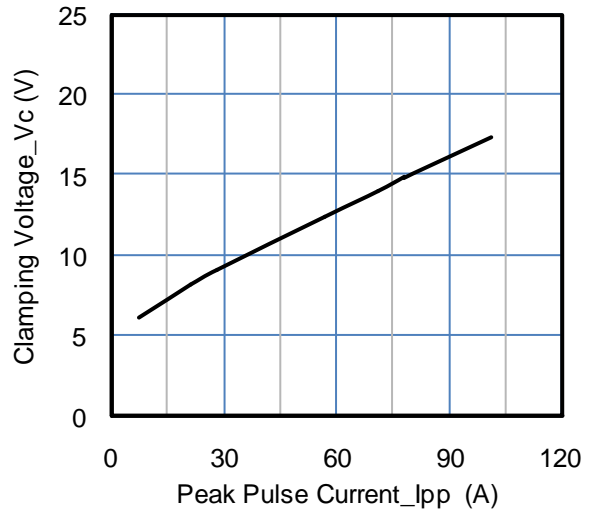

Fig2. Clamping Voltage vs. Peak Pulse Current

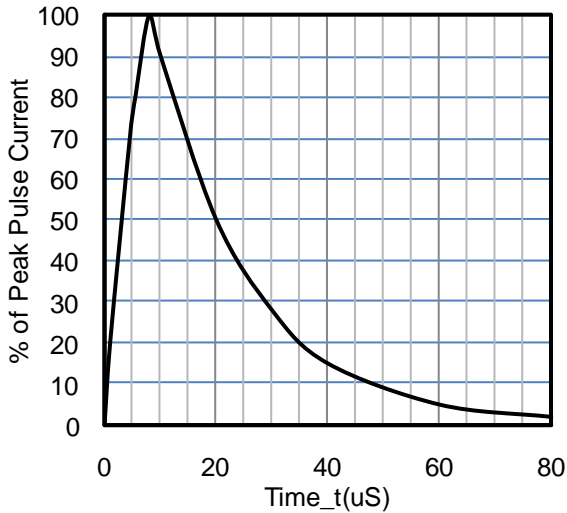

Fig3. 8 X 20uS Pulse Waveform

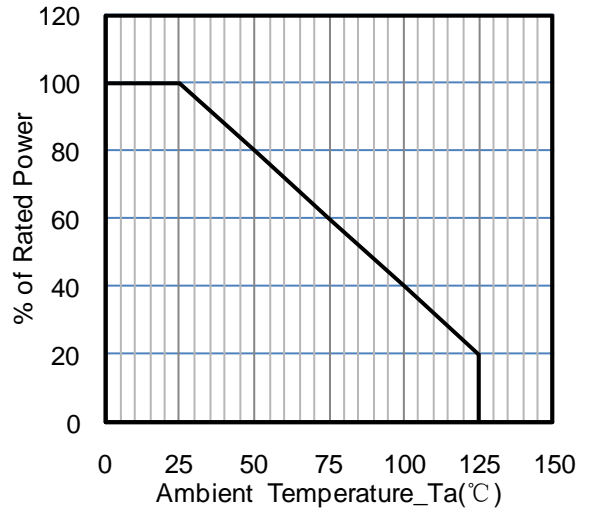

Fig4. Power Derating Curve

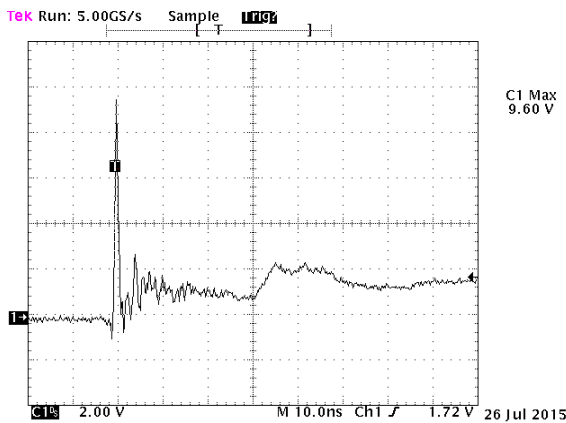

Fig 5. ESD Clamping Voltage
Positive 8 kV Contact per IEC61000-4-2

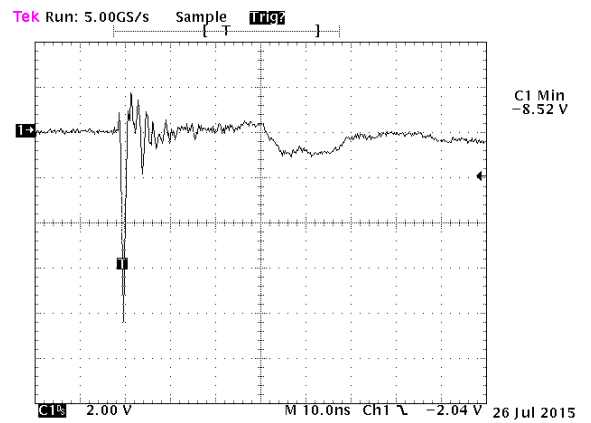
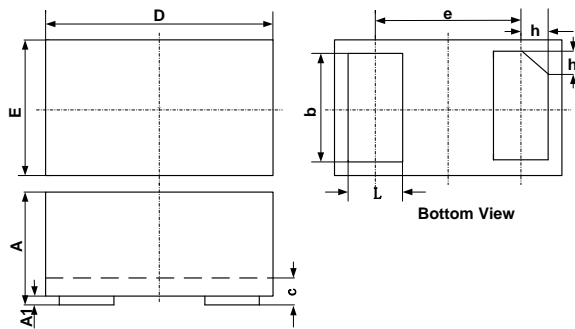

Fig 6. ESD Clamping Voltage
Negative 8 kV Contact per IEC61000-4-2

LTVS16H5.0T5G

DFN1610

DFN1610-2 Package Outline Drawing



SYM	DIMENSIONS					
	MILLIMETERS			INCHES		
	MIN	NOM	MAX	MIN	NOM	MAX
A	0.45	0.50	0.55	0.018	0.020	0.022
A1	0.00	0.02	0.05	0.000	0.001	0.002
b	0.75	0.80	0.85	0.030	0.032	0.034
c	0.10	0.15	0.20	0.004	0.006	0.008
D	1.55	1.60	1.65	0.062	0.064	0.066
e	1.10 BSC			0.044 BSC		
E	0.95	1.00	1.05	0.038	0.040	0.042
L	0.35	0.40	0.45	0.014	0.016	0.018
h	0.15	0.20	0.25	0.006	0.008	0.010

Suggested Land Pattern

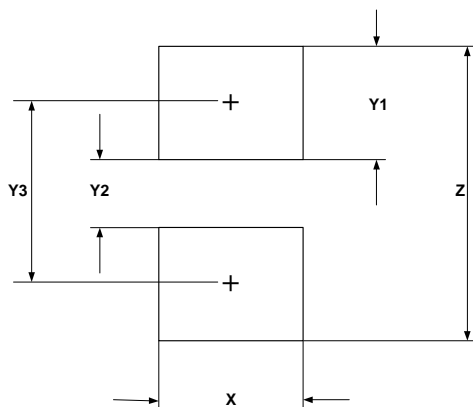

SYM	DIMENSIONS	
	MILLIMETERS	INCHES
X	1.00	0.040
Y1	0.62	0.025
Y2	0.60	0.024
Y3	1.22	0.049
Z	1.85	0.074