

## 1 Form A Solid-State Relay

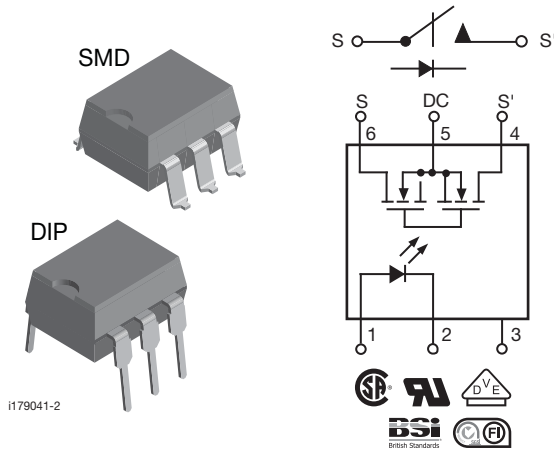

RoHS  
COMPLIANT

### FEATURES

- Current limit protection
- Isolation test voltage 5300 V<sub>RMS</sub>
- Typical R<sub>ON</sub> 20 Ω, max. 25 Ω
- Load voltage 350 V
- Load current 120 mA
- High surge capability
- Clean bounce free switching
- Low power consumption
- SMD lead available on tape and reel
- Compliant to RoHS Directive 2002/95/EC and in accordance to WEEE 2002/96/EC

### APPLICATIONS

- General telecom switching
- Instrumentation
- Industrial controls

### Note

- See “solid-state relays” (application note 56)

### AGENCY APPROVALS

UL1577: file no. E52744 system code H, double protection  
 CSA: certification no. 093751  
 BSI: certification no. 7979/7980  
 FIMKO: 25419  
 DIN EN: 60747-5-2 (VDE 0884)/60747-5-5 (pending), available with option 1

### DESCRIPTION

The LH1540 is robust, ideal for telecom and ground fault applications. It is an SPST normally open switch (form A) that replaces electromechanical relays in many applications. It is constructed using a GaAlAs LED for actuation control and an integrated monolithic die for the switch output. The die, fabricated in a high-voltage dielectrically isolated technology, is comprised of a photodiode array, switch control circuitry and MOSFET switches. In addition, it employs current-limiting circuitry which meets lightning surge testing as per ANSI/TIA-968-B and other regulatory voltage surge requirements when overvoltage protection is provided.

ORDERING INFORMATION													
L	H	1	5	4	0	#	#	#	T	R	DIP	SMD	
PART NUMBER						ELECTR. VARIATION	PACKAGE CONFIG.			TAPE AND REEL		7.62 mm	> 0.1 mm
<b>PACKAGE</b>						<b>UL, CSA, BSI, FIMKO</b>							
SMD-6						LH1540AAB							
SMD-6, tape and reel						LH1540AABTR							
DIP-6, thru hole						LH1540AT							



ABSOLUTE MAXIMUM RATINGS ( $T_{amb} = 25\text{ }^{\circ}\text{C}$ , unless otherwise specified)				
PARAMETER	TEST CONDITION	SYMBOL	VALUE	UNIT
<b>INPUT</b>				
LED continuous forward current		$I_F$	50	mA
LED reverse voltage	$I_R \leq 10\text{ }\mu\text{A}$	$V_R$	8	V
<b>OUTPUT</b>				
DC or peak AC load voltage	$I_L \leq 50\text{ }\mu\text{A}$	$V_L$	350	V
Continuous DC load current - bidirectional operation		$I_L$	120	mA
Continuous DC load current - unidirectional operation		$I_L$	250	mA
Peak load current (single shot)	$t = 100\text{ ms}$	$I_P$	(1)	mA
<b>SSR</b>				
Ambient temperature range		$T_{amb}$	- 40 to + 85	$^{\circ}\text{C}$
Storage temperature range		$T_{stg}$	- 40 to + 150	$^{\circ}\text{C}$
Pin soldering temperature (2)	$t = 10\text{ s max.}$	$T_{sld}$	260	$^{\circ}\text{C}$
Input to output isolation voltage		$V_{ISO}$	5300	$V_{RMS}$
Output power dissipation (continuous)		$P_{diss}$	550	mW

**Notes**

- Stresses in excess of the absolute maximum ratings can cause permanent damage to the device. Functional operation of the device is not implied at these or any other conditions in excess of those given in the operational sections of this document. Exposure to absolute maximum ratings for extended periods of the time can adversely affect reliability.

(1) Refer to current limit performance application note for a discussion on relay operation during transient currents.

(2) Refer to reflow profile for soldering conditions for surface mounted devices (SMD). Refer to wave profile for soldering conditions for through hole devices (DIP).

ELECTRICAL CHARACTERISTICS ( $T_{amb} = 25\text{ }^{\circ}\text{C}$ , unless otherwise specified)						
PARAMETER	TEST CONDITION	SYMBOL	MIN.	TYP.	MAX.	UNIT
<b>INPUT</b>						
LED forward current, switch turn-on	$I_L = 100\text{ mA}$ , $t = 10\text{ ms}$	$I_{Fon}$		1	2	mA
LED forward current, switch turn-off	$V_L = \pm 300\text{ V}$	$I_{Foff}$	0.2	0.9		mA
LED forward voltage	$I_F = 10\text{ mA}$	$V_F$	1.15	1.26	1.45	V
<b>OUTPUT</b>						
On-resistance AC/DC: pin 4 ( $\pm$ ) to 6 ( $\pm$ )	$I_F = 5\text{ mA}$ , $I_L = 50\text{ mA}$	$R_{ON}$	12	20	25	$\Omega$
On-resistance DC: pin 4, 6 (+) to 5 ( $\pm$ )	$I_F = 5\text{ mA}$ , $I_L = 100\text{ mA}$	$R_{ON}$	3	5	6.25	$\Omega$
Off-resistance	$I_F = 0\text{ mA}$ , $V_L = \pm 100\text{ V}$	$R_{OFF}$	0.5	5000		$G\Omega$
Current limit AC (1): pin 4 ( $\pm$ ) to 6 ( $\pm$ )	$I_F = 5\text{ mA}$ , $V_L = \pm 6\text{ V}$ , $t = 5\text{ ms}$	$I_{LMT}$	175	210	250	mA
Off-state leakage current	$I_F = 0\text{ mA}$ , $V_L = \pm 100\text{ V}$	$I_O$		0.32	200	nA
	$I_F = 0\text{ mA}$ , $V_L = \pm 350\text{ V}$	$I_O$			1	$\mu\text{A}$
Output capacitance pin 4 to 6	$I_F = 0\text{ mA}$ , $V_L = 1\text{ V}$	$C_O$		55		pF
	$I_F = 0\text{ mA}$ , $V_L = 50\text{ V}$	$C_O$		10		pF
Switch offset	$I_F = 5\text{ mA}$	$V_{OS}$		0.15		$\mu\text{V}$
<b>TRANSFER</b>						
Capacitance (input to output)	$V_{ISO} = 1\text{ V}$	$C_{IO}$		0.8		pF

**Notes**

- Minimum and maximum values are testing requirements. Typical values are characteristics of the device and are the result of engineering evaluations. Typical values are for information only and are not part of the testing requirements.

(1) No DC mode current limit available.

SWITCHING CHARACTERISTICS ( $T_{amb} = 25\text{ }^{\circ}\text{C}$ , unless otherwise specified)						
PARAMETER	TEST CONDITION	SYMBOL	MIN.	TYP.	MAX.	UNIT
Turn-on time	$I_F = 5\text{ mA}$ , $I_L = 50\text{ mA}$	$t_{on}$		1.2	2	ms
Turn-off time	$I_F = 5\text{ mA}$ , $I_L = 50\text{ mA}$	$t_{off}$		0.5	2	ms



SAFETY AND INSULATION RATINGS				
PARAMETER	TEST CONDITION	SYMBOL	VALUE	UNIT
Climatic classification	IEC 68 part 1		40/85/21	
Pollution degree	DIN VDE 0109		2	
Tracking resistance (comparative tracking index)	Insulation group IIIa	CTI	175	
Highest allowable overvoltage	Transient overvoltage	$V_{IOTM}$	8000	$V_{peak}$
Max. working insulation voltage	Recurring peak voltage	$V_{IORM}$	890	$V_{peak}$
Insulation resistance at 25 °C	$V_{IO} = 500 V$	$R_{IS}$	$\geq 10^{12}$	$\Omega$
Insulation resistance at $T_S$		$R_{IS}$	$\geq 10^9$	$\Omega$
Insulation resistance at 100 °C		$R_{IS}$	$\geq 10^{11}$	$\Omega$
Partial discharge test voltage	Method e, $V_{pd} = V_{IORM} \times 1.875$	$V_{pd}$	1669	$V_{peak}$
Safety limiting values - maximum values allowed in the event of a failure	Case temperature	$T_{SI}$	175	°C
	Input current	$I_{SI}$	300	mA
	Output power	$P_{SO}$	700	mW
Minimum external air gap (clearance)	Measured from input terminals to output terminals, shortest distance through air		$\geq 7$	mm
Minimum external tracking (creepage)	Measured from input terminals to output terminals, shortest distance path along body		$\geq 7$	mm

**TYPICAL CHARACTERISTICS** ( $T_{amb} = 25\text{ °C}$ , unless otherwise specified)

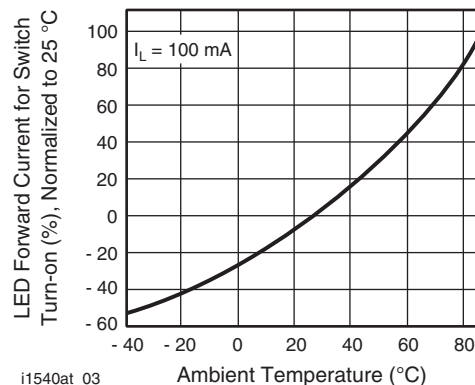
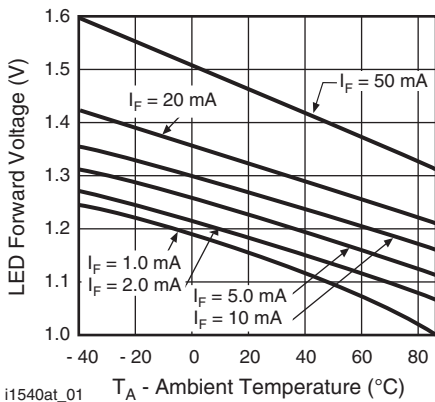
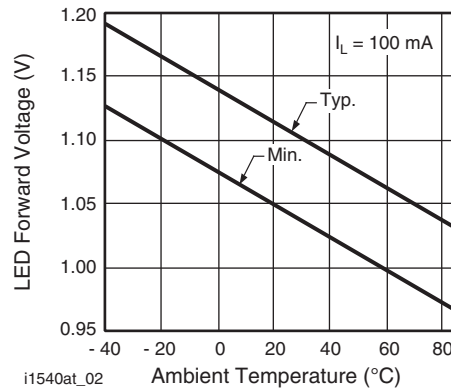

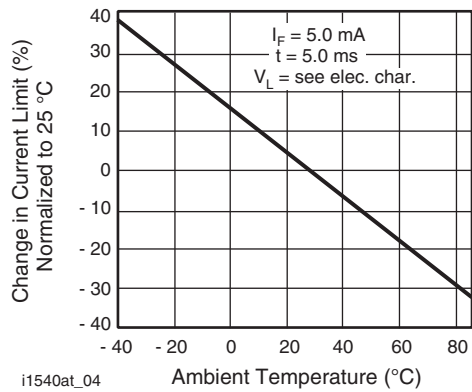

Fig. 5 - Current Limit vs. Temperature

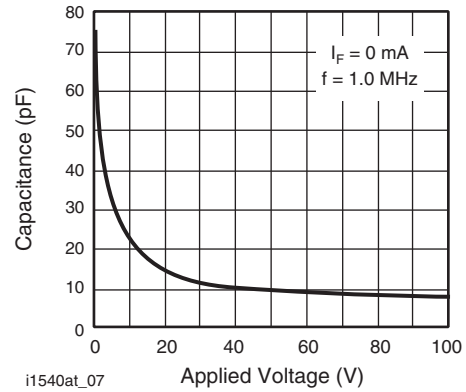

Fig. 8 - Switch Capacitance vs. Applied Voltage

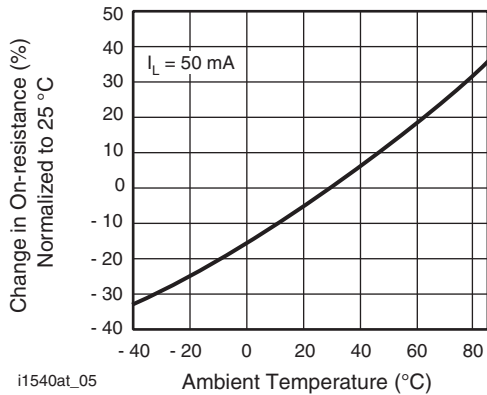

Fig. 6 - On-resistance vs. Temperature

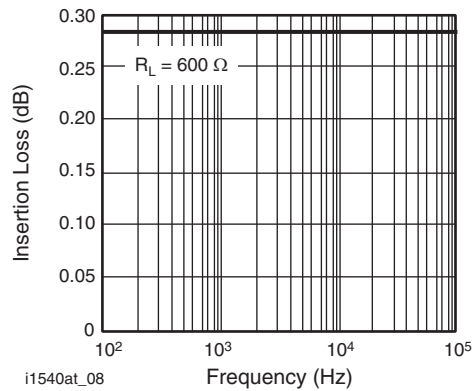

Fig. 9 - Insertion Loss vs. Frequency

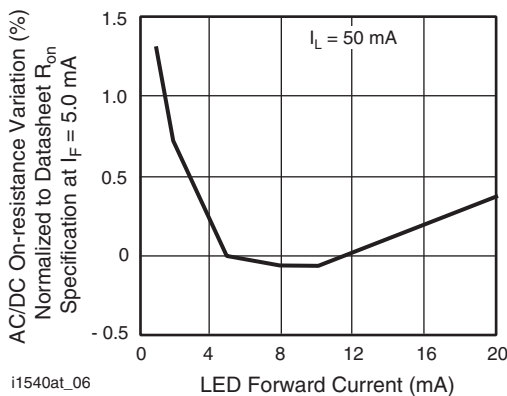

Fig. 7 - Variation in On-resistance vs. LED Current

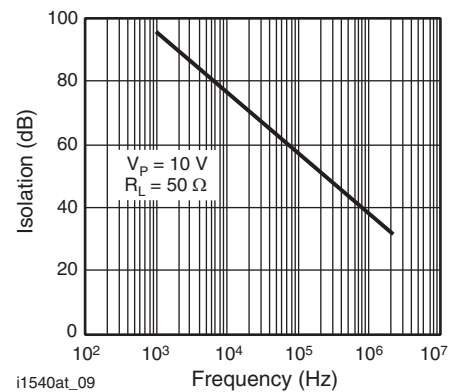

Fig. 10 - Output Isolation



Fig. 11 - Leakage Current vs. Applied Voltage

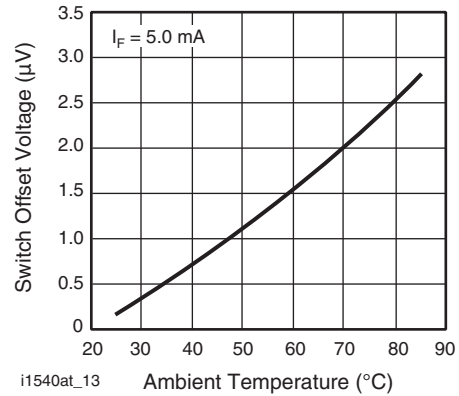

Fig. 14 - Switch Offset Voltage vs. Temperature



Fig. 12 - Leakage Current vs. Applied Voltage at Elevated Temperatures

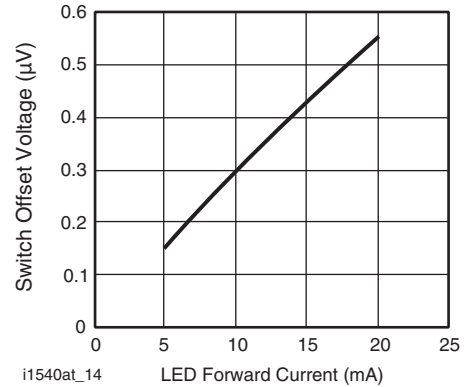

Fig. 15 - Switch Offset Voltage vs. LED Current

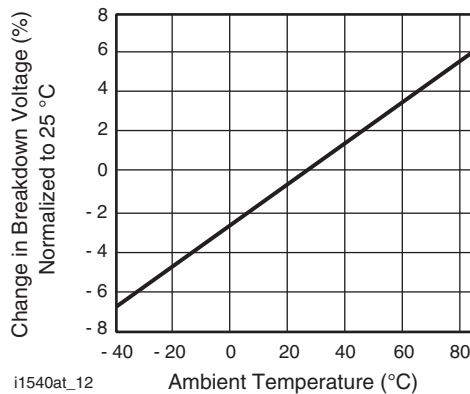

Fig. 13 - Switch Breakdown Voltage vs. Temperature

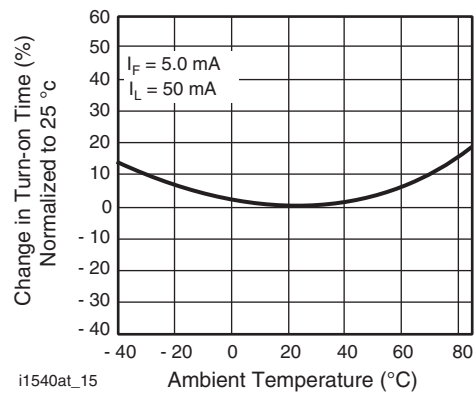

Fig. 16 - Turn-on Time vs. Temperature



Fig. 17 - Turn-off Time vs. Temperature

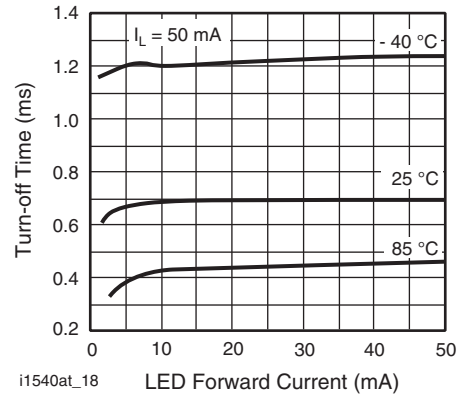

Fig. 19 - Turn-off Time vs. LED Current



Fig. 18 - Turn-on Time vs. LED Current

## PACKAGE DIMENSIONS in millimeters





## PACKAGE MARKING



### Note

- Tape and reel suffix (TR) is not part of the package marking.



## Footprint and Schematic Information for LH1540

The footprint and schematic symbols for the following parts can be accessed using the associated links. They are available in Eagle, Altium, KiCad, OrCAD / Allegro, Pulsonix, and PADS.

Note that the 3D models for these parts can be found on the Vishay product page.

PART NUMBER	FOOTPRINT / SCHEMATIC
LH1540AAB	<a href="http://www.snapeda.com/parts/LH1540AAB/Vishay/view-part">www.snapeda.com/parts/LH1540AAB/Vishay/view-part</a>
LH1540AABTR	<a href="http://www.snapeda.com/parts/LH1540AABTR/Vishay/view-part">www.snapeda.com/parts/LH1540AABTR/Vishay/view-part</a>
LH1540ACD	<a href="http://www.snapeda.com/parts/LH1540ACD/Vishay/view-part">www.snapeda.com/parts/LH1540ACD/Vishay/view-part</a>
LH1540ACDTR	<a href="http://www.snapeda.com/parts/LH1540ACDTR/Vishay/view-part">www.snapeda.com/parts/LH1540ACDTR/Vishay/view-part</a>
LH1540AT	<a href="http://www.snapeda.com/parts/LH1540AT/Vishay/view-part">www.snapeda.com/parts/LH1540AT/Vishay/view-part</a>

For technical issues and product support, please contact [optocoupleranswers@vishay.com](mailto:optocoupleranswers@vishay.com).

SMD

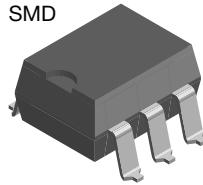

DIP

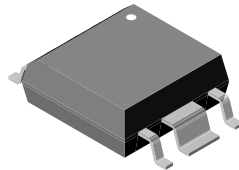
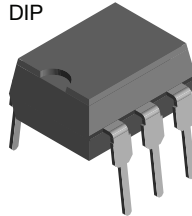





## **Disclaimer**

ALL PRODUCT, PRODUCT SPECIFICATIONS AND DATA ARE SUBJECT TO CHANGE WITHOUT NOTICE TO IMPROVE RELIABILITY, FUNCTION OR DESIGN OR OTHERWISE.

Vishay Intertechnology, Inc., its affiliates, agents, and employees, and all persons acting on its or their behalf (collectively, "Vishay"), disclaim any and all liability for any errors, inaccuracies or incompleteness contained in any datasheet or in any other disclosure relating to any product.

Vishay makes no warranty, representation or guarantee regarding the suitability of the products for any particular purpose or the continuing production of any product. To the maximum extent permitted by applicable law, Vishay disclaims (i) any and all liability arising out of the application or use of any product, (ii) any and all liability, including without limitation special, consequential or incidental damages, and (iii) any and all implied warranties, including warranties of fitness for particular purpose, non-infringement and merchantability.

Statements regarding the suitability of products for certain types of applications are based on Vishay's knowledge of typical requirements that are often placed on Vishay products in generic applications. Such statements are not binding statements about the suitability of products for a particular application. It is the customer's responsibility to validate that a particular product with the properties described in the product specification is suitable for use in a particular application. Parameters provided in datasheets and / or specifications may vary in different applications and performance may vary over time. All operating parameters, including typical parameters, must be validated for each customer application by the customer's technical experts. Product specifications do not expand or otherwise modify Vishay's terms and conditions of purchase, including but not limited to the warranty expressed therein.

Except as expressly indicated in writing, Vishay products are not designed for use in medical, life-saving, or life-sustaining applications or for any other application in which the failure of the Vishay product could result in personal injury or death. Customers using or selling Vishay products not expressly indicated for use in such applications do so at their own risk. Please contact authorized Vishay personnel to obtain written terms and conditions regarding products designed for such applications.

No license, express or implied, by estoppel or otherwise, to any intellectual property rights is granted by this document or by any conduct of Vishay. Product names and markings noted herein may be trademarks of their respective owners.