

**LB1836M**

## Low-saturation, Bidirectional Motor Driver for Low-voltage Applications

### Overview

The LB1836M is a low-saturation two-channel bidirectional motor driver IC for use in low-voltage applications. The LB1836M is a bipolar stepper-motor driver IC that is ideal for use in printers, FDDs, cameras and other portable devices.

### Features

- Low voltage operation (2.5 V min)
- Low saturation voltage (upper transistor + lower transistor residual voltage; 0.40 V typ at 400 mA).
- Parallel connection  
(Upper transistor + lower transistor residual voltage; 0.5 V typ at 800 mA).
- Separate logic power supply and motor power supply
- Brake function
- Spark killer diodes built in
- Thermal shutdown circuit built in
- Compact package (14-pin MFP)

### Package Dimensions

unit : mm

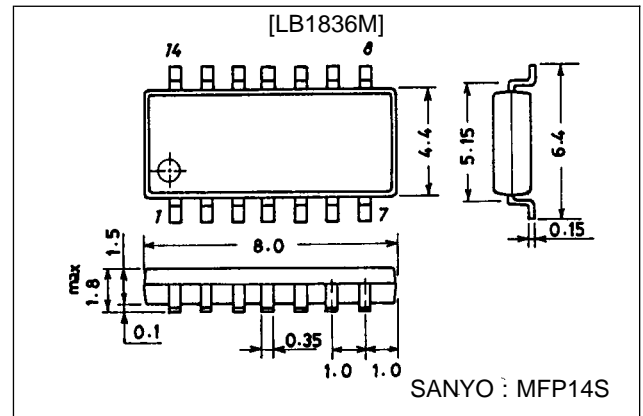
**3111-MFP14S**

### Specifications

#### Absolute Maximum Ratings at $T_a = 25^\circ\text{C}$

Parameter	Symbol	Conditions	Ratings	Unit
Maximum supply voltage	$V_{CC}$ max		-0.3 to +10.5	V
	$V_S$ max		-0.3 to +10.5	V
Output applied voltage	$V_{OUT}$		$V_S + V_{SF}$	V
Input applied voltage	$V_{IN}$		-0.3 to +10	V
Ground pin flow-out current	IGND	Per channel	1.0	A
Allowable power dissipation	$P_d$ max	* With board	800	mW
Operating temperature	$T_{opr}$		-20 to +75	$^\circ\text{C}$
Storage temperature	$T_{stg}$		-40 to +125	$^\circ\text{C}$

\*Note: Mounted on  $30 \times 30 \times 1.5 \text{ mm}^3$  glass epoxy PCB

#### Allowable Operating Ranges at $T_a = 25^\circ\text{C}$

Parameter	Symbol	Conditions	Ratings	Unit
Supply voltage	$V_{CC}$		2.5 to 9.0	V
	$V_S$		1.8 to 9.0	V
Input high-level voltage	$V_{IH}$		1.8 to 9.0	V
Input low-level voltage	$V_{IL}$		-0.3 to +0.7	V

## LB1836M

### Electrical Characteristics at Ta = 25°C, V<sub>CC</sub> = V<sub>S</sub> = 3 V

Parameter	Symbol	Conditions	min	typ	max	Unit
Supply current	I <sub>CC0</sub>	V <sub>IN1, 2, 3, 4</sub> = 0 V, I <sub>CC</sub> + I <sub>S</sub>		0.1	10	μA
	I <sub>CC1</sub>	V <sub>IN1</sub> = 3 V, V <sub>IN2, 3, 4</sub> = 0 V, I <sub>CC</sub> + I <sub>S</sub>		14	20	mA
	I <sub>CC2</sub>	V <sub>IN1, 2</sub> = 3 V, V <sub>IN3, 4</sub> = 0 V, I <sub>CC</sub> + I <sub>S</sub>		22	35	mA
Output saturation voltage (upper + lower)	V <sub>OUT1</sub>	I <sub>OUT</sub> = 200 mA		0.2	0.28	V
	V <sub>OUT2</sub>	I <sub>OUT</sub> = 400 mA		0.4	0.6	V
	V <sub>OUT3</sub>	I <sub>OUT</sub> = 400 mA, parallel connection		0.25	0.35	V
	V <sub>OUT4</sub>	I <sub>OUT</sub> = 800 mA, parallel connection		0.5	0.7	V
Output sustaining voltage	V <sub>O (sus)</sub>	I <sub>OUT</sub> = 400 mA	9			V
Input current	I <sub>IN</sub>	V <sub>IN</sub> = 2 V, V <sub>CC</sub> = 6 V			80	μA
Spark killer diode reverse current	I <sub>S (leak)</sub>	V <sub>CC1, 2</sub> = 9 V			30	μA
Spark killer diode forward voltage	V <sub>SF</sub>	I <sub>OUT</sub> = 400 mA			1.7	V

### Pin Assignment

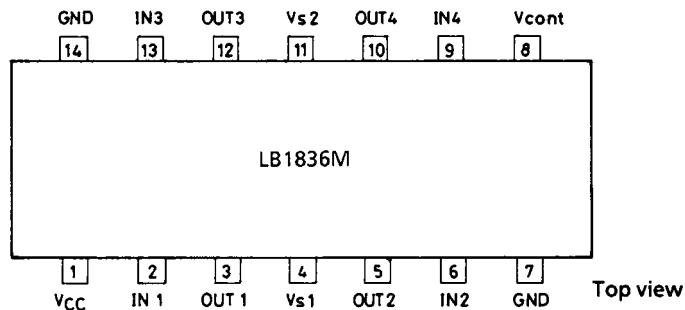

Note) Both GNDs must be connected. P-GND of OUT2 and OUT4 and S-GND of the control section are connected to the pin 7 GND within the IC, and P-GND of OUT1 and OUT3 is connected to the pin 14 GND.

### Truth Table

IN 1, 3	IN 2, 4	OUT 1, 3	OUT 2, 4	Mode
H	L	H	L	Forward
L	H	L	H	Reverse
H	H	L	L	Brake
L	L	OFF	OFF	Standby

### Design Notes

If large current flows on the power supply (V<sub>S</sub>) line and the GND line, then in some applications and layouts, misoperation due to line oscillation may result.

The modes during which large current flows are as follows:

- Motor surge current when the DC motor starts up or when it shifts rotation directions (forward ⇌ reverse).
- Passthrough current generated within the IC when shifting rotation directions (forward ⇌ reverse) or when shifting from forward/reverse rotation to braking, or vice versa.

The following points should be kept in mind regarding the pattern layout:

- Keep the wiring lines thick and short in order to reduce wiring inductance between the power supply (V<sub>S</sub>) and GND.
- Insert a passthrough capacitor near the IC. (Maximum effect is obtained by inserting the passthrough capacitor between V<sub>S</sub> and the pin 7 GND at the closest distance possible.)
- If the CPU and the LB1836M are mounted on separate boards and the difference between the ground potential of each board is large, install resistors of about 10 kΩ in series between the CPU and the LB1836M inputs.

Block Diagram

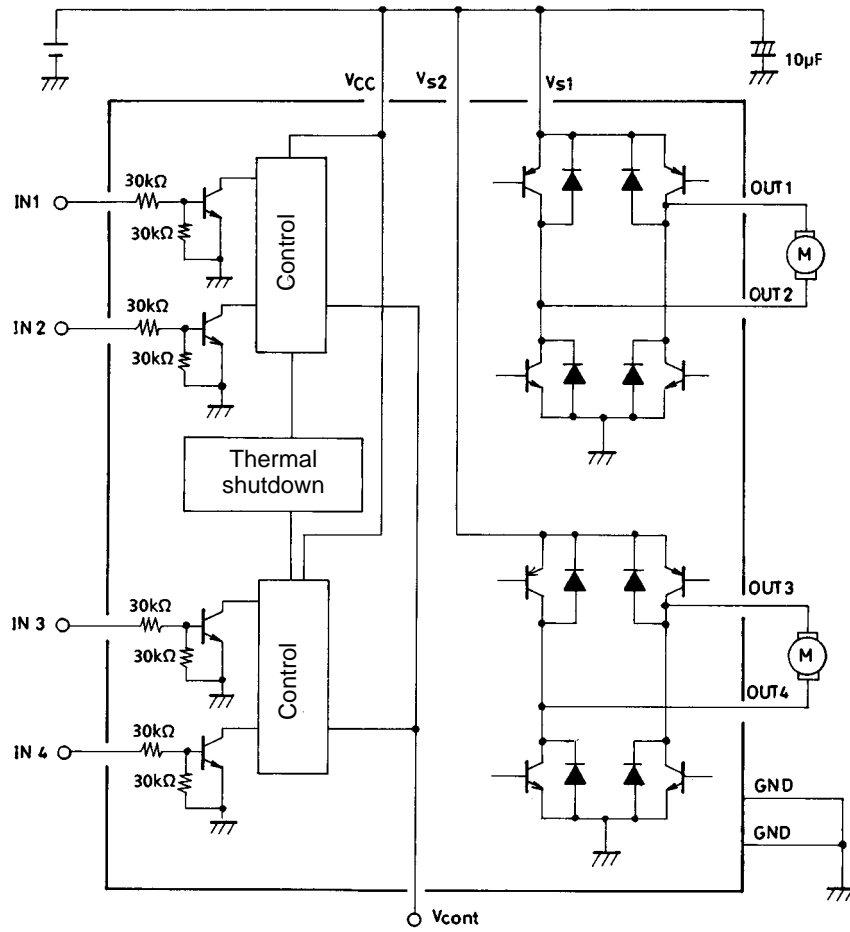

Note: As long as the voltages applied to  $V_{CC}$ ,  $V_{S1}$ ,  $V_{S2}$ , and  $IN1$  through  $IN4$  are within the limits set by the absolute maximum ratings, there are no restrictions on the relationship of each voltage level in comparison with the others (regarding which is higher or lower). (ex.  $V_{CC} = 3\text{ V}$ ,  $V_{S1, 2} = 2\text{ V}$ ,  $IN1$  to  $IN4 = 5\text{ V}$ )

Vcont pin

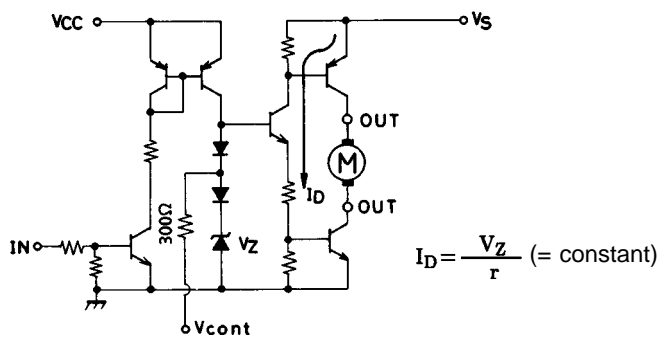

As shown in the above diagram, the  $V_{cont}$  pin outputs the voltage of the band gap Zener  $V_Z + V_F (= 1.93\text{ V})$ .

In normal use, this pin is left open.

The drive current  $I_D$  is varied by the  $V_{cont}$  voltage. However, because the band gap Zener is shared, it functions as a bridge.

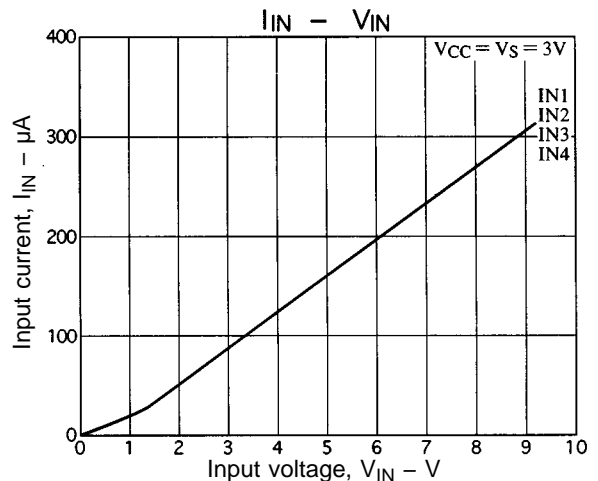
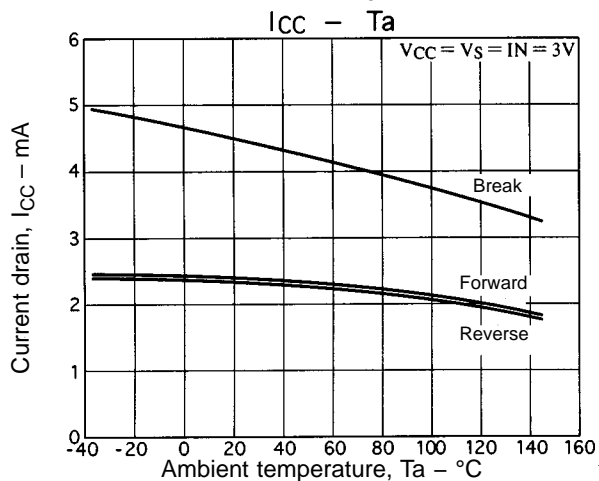
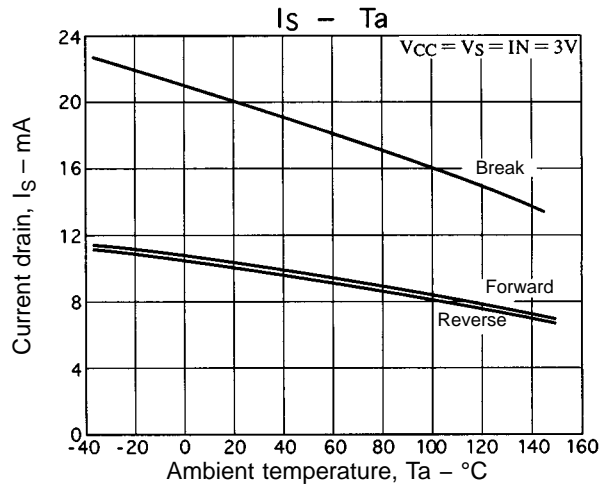
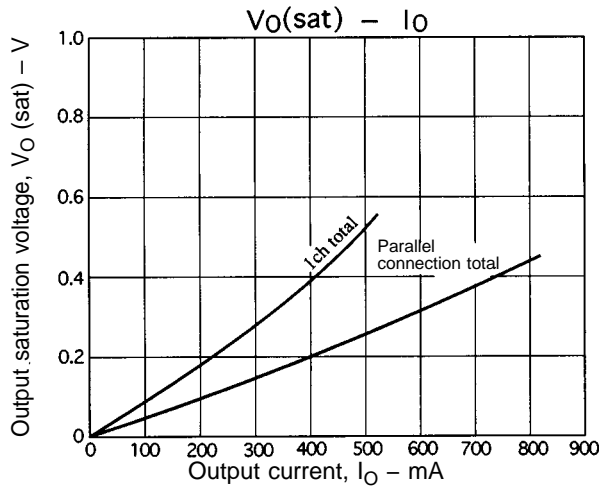
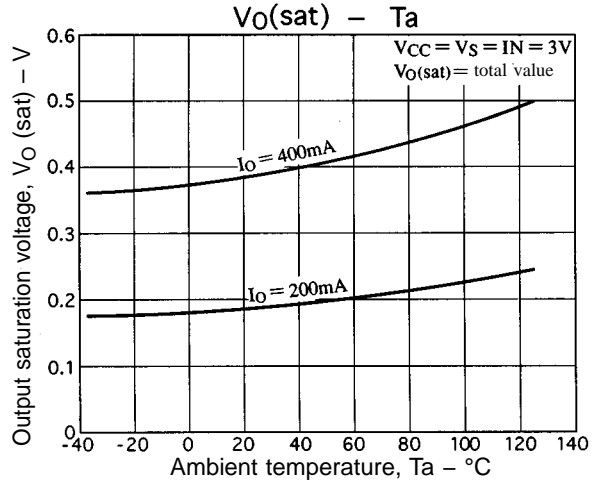
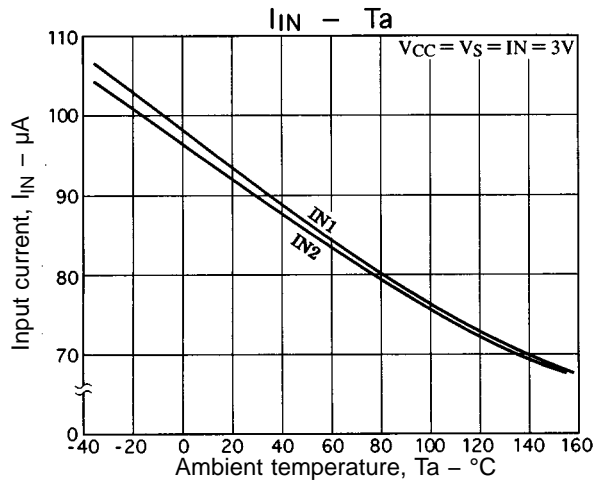
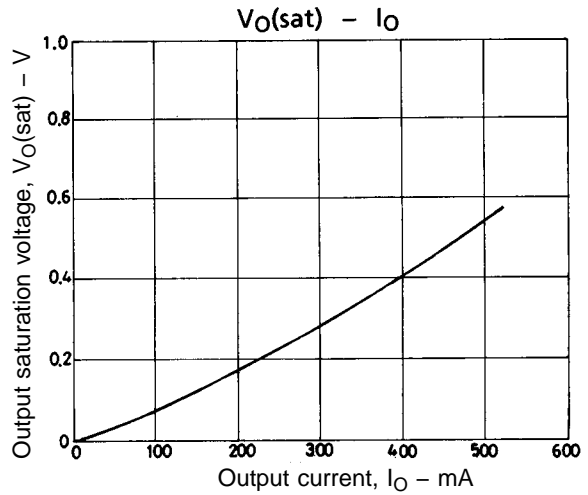
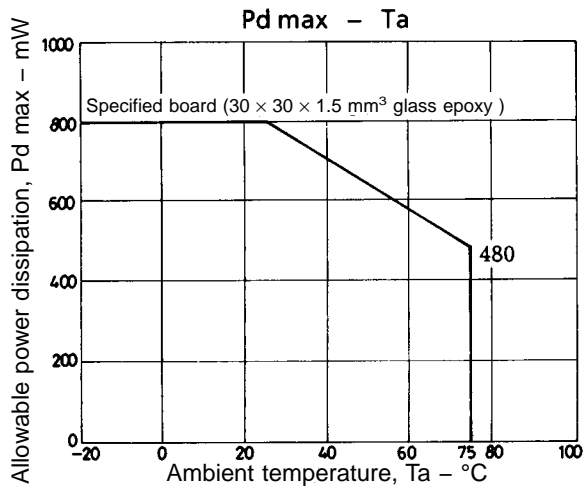

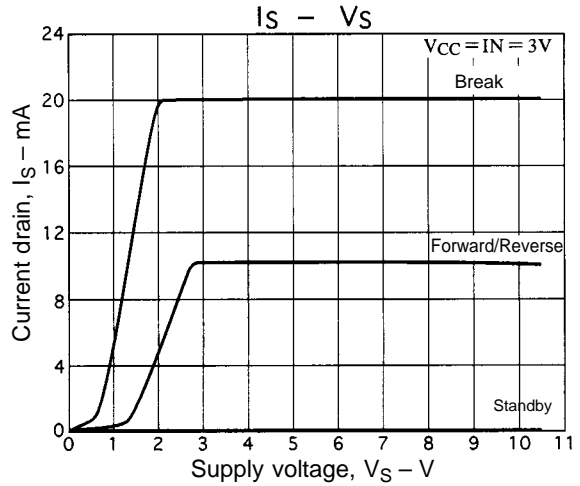
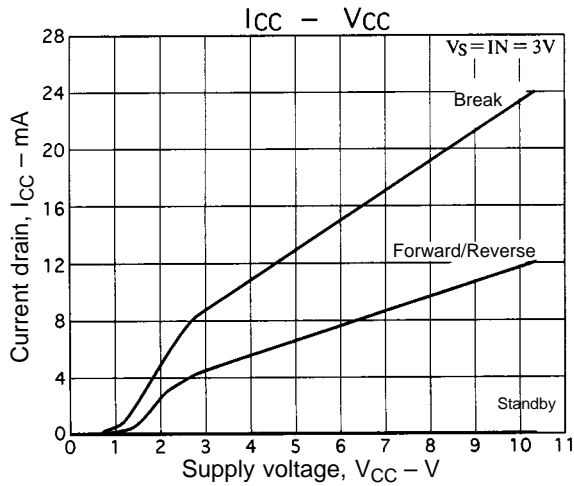

- No products described or contained herein are intended for use in surgical implants, life-support systems, aerospace equipment, nuclear power control systems, vehicles, disaster/crime-prevention equipment and the like, the failure of which may directly or indirectly cause injury, death or property loss.
- Anyone purchasing any products described or contained herein for an above-mentioned use shall:
  - ① Accept full responsibility and indemnify and defend SANYO ELECTRIC CO., LTD., its affiliates, subsidiaries and distributors and all their officers and employees, jointly and severally, against any and all claims and litigation and all damages, cost and expenses associated with such use:
  - ② Not impose any responsibility for any fault or negligence which may be cited in any such claim or litigation on SANYO ELECTRIC CO., LTD., its affiliates, subsidiaries and distributors or any of their officers and employees jointly or severally.
- Information (including circuit diagrams and circuit parameters) herein is for example only; it is not guaranteed for volume production. SANYO believes information herein is accurate and reliable, but no guarantees are made or implied regarding its use or any infringements of intellectual property rights or other rights of third parties.

This catalog provides information as of February, 1997. Specifications and information herein are subject to change without notice.