

Small Signal MOSFET 380 mAmps, 60 Volts N-Channel SOT-23

L2N7002KLT1G S-L2N7002KLT1G

●FEATURES

- 1)ESD Protected
- 2)Low RDS(on)
- 3)Surface Mount Package
- 4)This is a Pb-Free Device
- 5)We declare that the material of product compliant with RoHS requirements and Halogen Free.
- 6)S- Prefix for Automotive and Other Applications Requiring Unique Site and Control Change Requirements; AEC-Q101 Qualified and PPAP Capable.

●APPLICATIONS

- 1)Low Side Load Switch
- 2)Level Shift Circuits
- 3)DC-DC Converter
- 4)Portable Applications i.e. DSC, PDA, Cell Phone, etc.

●DEVICE MARKING AND ORDERING INFORMATION

Device	Marking	Shipping
L2N7002KLT1G	RK	3000/Tape&Reel

●MAXIMUM RATINGS(T_j= 25°C unless otherwise stated))

Rating	Symbol	Value	Unit
Drain-to-Source Voltage	V _{DSS}	60	Vdc
Gate-to-Source Voltage	V _{GS}	±20	Vdc
Drain Current	I _D		mA
		– Steady State	
		T _A = 85°C	230
– t < 5 s		T _A = 25°C	380
		T _A = 85°C	270
Power Dissipation (Note 1)	P _D	Steady State	300
		t < 5 s	420
Pulsed Drain Current (tp = 10 μs)	I _{DM}	1.5	A
Operating Junction and Storage Temperature Range	T _J , T _{STG}	-55 to +150	°C
Source Current (Body Diode)	I _S	300	mA
Lead Temperature for Soldering Purposes (1/8 " from case for 10 s)	T _L	260	°C
Gate-Source ESD Rating (HBM, Method 3015)	ESD	2000	V

Stresses exceeding Maximum Ratings may damage the device. Maximum Ratings are stress ratings only. Functional operation above the Recommended Operating Conditions is not implied. Extended exposure to stresses above the Recommended Operating Conditions may affect device reliability.

1. Surface-mounted on FR4 board using 1 in sq pad size (Cu area = 1.127 in sq [1 oz] including traces)

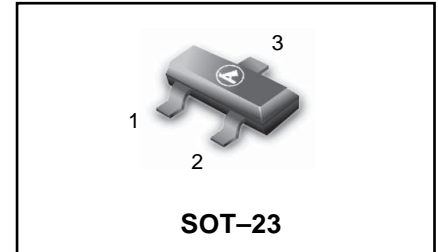

V _{(BR)DSS}	R _{DS(on) MAX}	I _{D MAX} (Note 1)
60 V	2.3 Ω @ 10 V	380 mA
	2.7 Ω @ 5.0 V	

Simplified Schematic

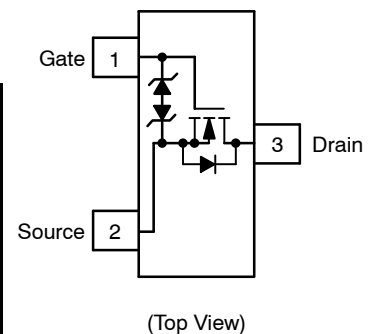

L2N7002KLT1G,S-L2N7002KLT1G
● THERMAL CHARACTERISTICS

Characteristic	Max	Value	Unit
Junction-to-Ambient - Steady	$R_{\theta JA}$	417	°C/W
Junction-to-Ambient - $t \leq 5$ s	$R_{\theta JA}$	300	

● ELECTRICAL CHARACTERISTICS (Ta= 25°C)

Characteristic	Symbol	Test Condition	Min.	Typ.	Max.	Unit
----------------	--------	----------------	------	------	------	------

OFF CHARACTERISTICS

Drain-to-Source Breakdown Voltage	$V_{(BR)DSS}$	$V_{GS} = 0$ V, $I_D = 250$ μ A	60			V
Drain-to-Source Breakdown Voltage Temperature Coefficient	$V_{(BR)DSS}/T_J$			71		mV/°C
Zero Gate Voltage Drain Current	I_{DSS}	$V_{GS} = 0$ V, $V_{DS} = 60$ V	$T_J = 25^\circ$ C		1	μ A
			$T_J = 125^\circ$ C		500	
		$V_{GS} = 0$ V, $V_{DS} = 50$ V	$T_J = 25^\circ$ C		100	nA
Gate-to-Source Leakage Current	I_{GSS}	$V_{DS} = 0$ V, $V_{GS} = \pm 20$ V			± 10	μ A

ON CHARACTERISTICS (Note 2.)

Gate Threshold Voltage	$V_{GS(TH)}$	$V_{GS} = V_{DS}$, $I_D = 250$ μ A	1		2.5	V
Negative Threshold Temperature Coefficient	$V_{GS(TH)}/T_J$			4		mV/°C
Drain-to-Source On Resistance	$R_{DS(on)}$	$V_{GS} = 10$ V, $I_D = 500$ mA			2.3	Ω
		$V_{GS} = 5.0$ V, $I_D = 50$ mA			2.7	
Forward Transconductance	G_{fs}	$V_{DS} = 5$ V, $I_D = 200$ mA	80			mS

CHARGES AND CAPACITANCES

Input Capacitance	C_{ISS}	$V_{GS} = 0$ V, $f = 1$ MHz, $V_{DS} = 25$ V		34		μ F
Output Capacitance	C_{OSS}			3		
Reverse Transfer Capacitance	C_{RSS}			2.2		
Total Gate Charge	$Q_{G(TOT)}$	$V_{GS} = 4.5$ V, $V_{DS} = 10$ V; $I_D = 500$ mA		0.71		nC
Threshold Gate Charge	$Q_{G(TH)}$			0.1		
Gate-to-Source Charge	Q_{GS}			0.32		
Gate-to-Drain Charge	Q_{GD}			0.16		

SWITCHING CHARACTERISTICS (VGS = V (Note 3))

Turn-On Delay Time	$t_{d(ON)}$	$V_{DS} = 10$ V, $V_{GEN} = 10$ V, $I_D = 500$ mA		3.8		ns
Rise Time	t_r			3.4		
Turn-Off Delay Time	$t_{d(OFF)}$			19		
Fall Time	t_f			12		

DRAIN-SOURCE DIODE CHARACTERISTICS

Forward Diode Voltage	V_{SD}	$V_{GS} = 0$ V, $I_S = 115$	$T_J = 25^\circ$ C		1.4	V
			$T_J = 85^\circ$ C		0.7	

 2. Pulse Test: pulse width ≤ 300 μ s, duty cycle $\leq 2\%$

3. Switching characteristics are independent of operating junction temperatures

L2N7002KLT1G,S-L2N7002KLT1G

ELECTRICAL CHARACTERISTIC CURVES

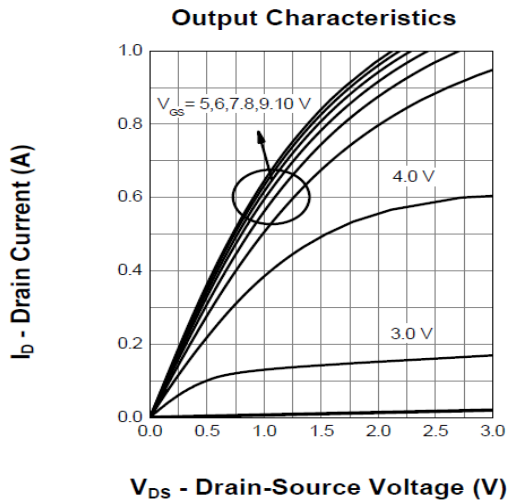

Fig. 1

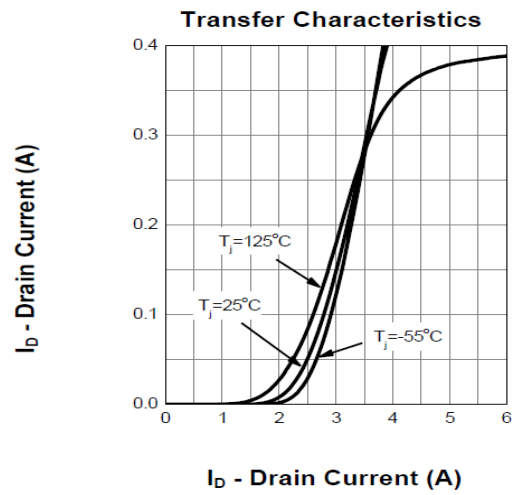

Fig. 2

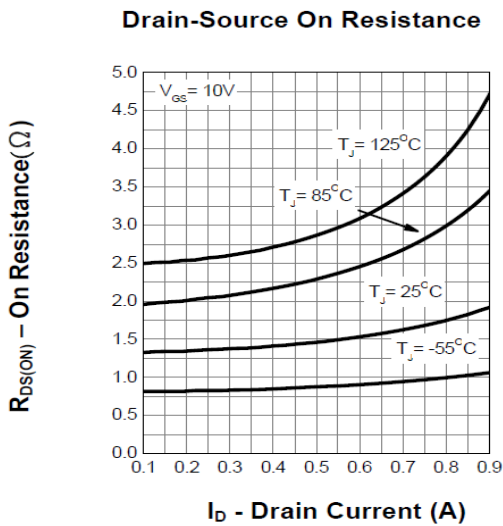

Fig. 3

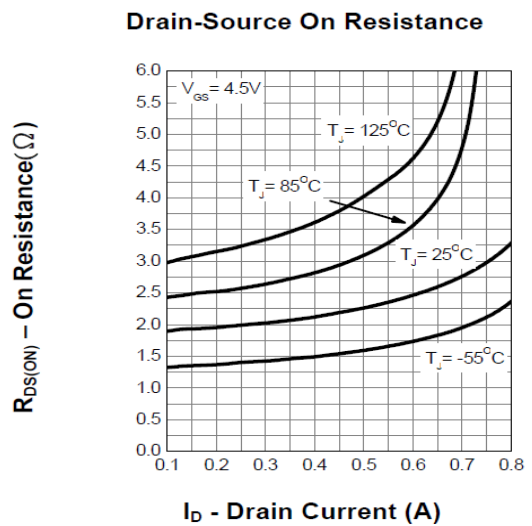

Fig. 4

L2N7002KLT1G,S-L2N7002KLT1G

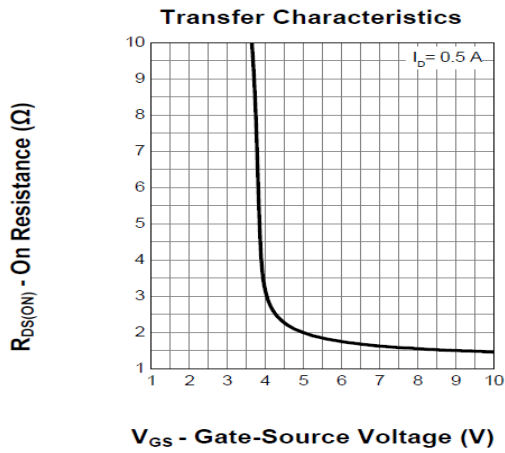

Fig. 5

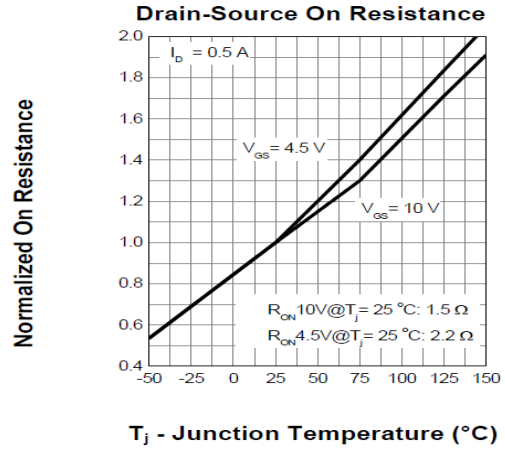

Fig. 6

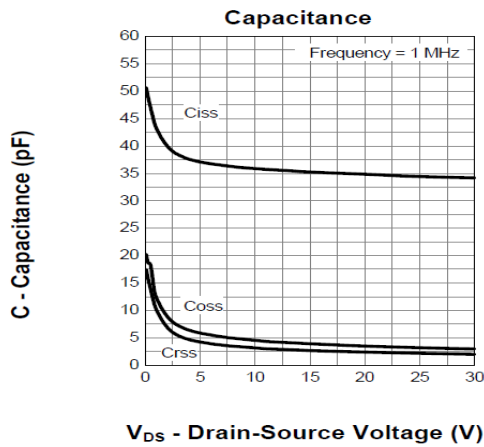

Fig. 7

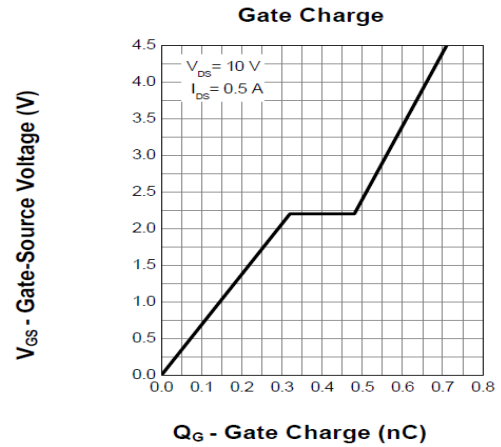

Fig. 8

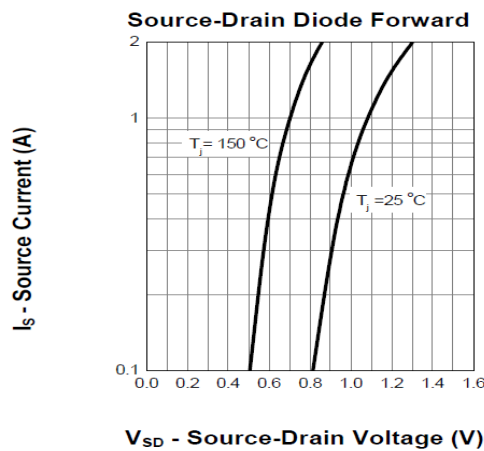
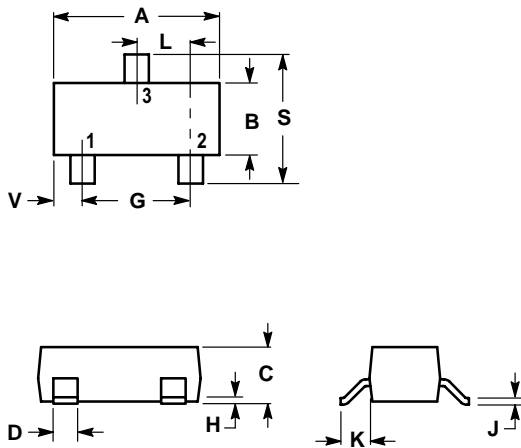

Fig. 9

L2N7002KLT1G,S-L2N7002KLT1G

SOT-23

Dimension Outline:



NOTES:

1. DIMENSIONING AND TOLERANCING PER ANSI Y14.5M,1982
2. CONTROLLING DIMENSION: INCH.

DIM	INCHES		MILLIMETERS	
	MIN	MAX	MIN	MAX
A	0.1102	0.1197	2.80	3.04
B	0.0472	0.0551	1.20	1.40
C	0.0350	0.0440	0.89	1.11
D	0.0150	0.0200	0.37	0.50
G	0.0701	0.0807	1.78	2.04
H	0.0005	0.0040	0.013	0.100
J	0.0034	0.0070	0.085	0.177
K	0.0140	0.0285	0.35	0.69
L	0.0350	0.0401	0.89	1.02
S	0.0830	0.1039	2.10	2.64
V	0.0177	0.0236	0.45	0.60

Soldering Footprint:

