

1. Features

- n $R_{DS(on)}=5.5m\Omega @ V_{GS}=10V$
- n Lead free and green device available
- n Low Rds-on to minimize conductive loss
- n High avalanche current

2. Applications

- n Power Supply
- n UPS
- n Power Tool

3. Symbol

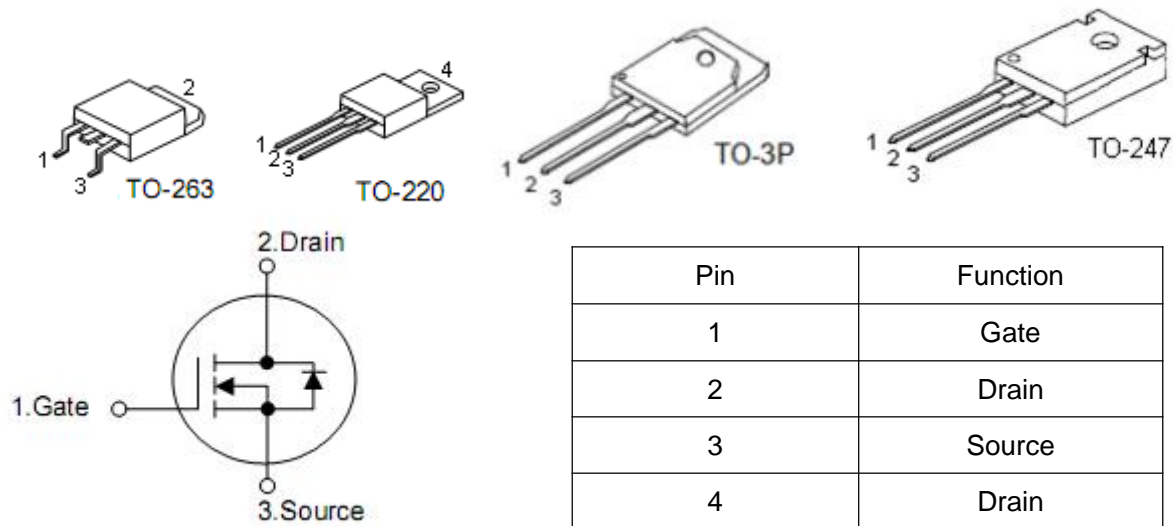

4. Absolute maximum ratings

Parameter	Symbol	Rating		Units	
		To-220/263	To-247/3P		
Drain-source voltage	V_{DSS}	60		V	
Gate-source voltage	V_{GSS}	± 25		V	
Junction and storage temperature range	T_{STG}	-55 to 175		$^{\circ}C$	
Continuous drain current	I_D^3	$T_C=25^{\circ}C$	130	A	
		$T_C=100^{\circ}C$	90	A	
Pulse drain current	I_{DP}^4	$T_C=25^{\circ}C$ 360		A	
Avalanche current	I_{AS}^5	25		A	
Maximum power dissipation	E_{AS}^5	250		mJ	
Maximum power dissipation	P_D	$T_C=25^{\circ}C$	200	300	W
		$T_C=100^{\circ}C$	90	150	W

5. Thermal characteristics

Parameter	Symbol	Rating		Unit
		To-220/263	To-247/3P	
Thermal resistance, Junction-ambient	$R_{\theta JA}$	62.5		$^{\circ}C/W$
Thermal resistance, Junction-case	$R_{\theta JC}$	0.75	0.5	$^{\circ}C/W$

6. Electrical characteristics

($T_A=25^{\circ}\text{C}$, unless otherwise noted)

Parameter	Symbol	Test Conditions	Min	Typ	Max	Units
Drain-source breakdown voltage	BV_{DSS}	$V_{GS}=0V, I_{DS}=250\mu A$	60	-	-	V
Zero gate voltage drain current	I_{DSS}	$V_{DS}=48V, V_{GS}=0V$	-	-	1	μA
		$T_J=125^{\circ}\text{C}$	-	-	30	
Gate threshold voltage	$V_{GS(th)}$	$V_{DS}=V_{GS}, I_D=250\mu A$	2	3	4	V
Gate leakage current	I_{GSS}	$V_{GS}=\pm 25V, V_{DS}=0V$	-	-	± 100	nA
Drain-source on-state resistance	$R_{DS(on)}^1$	$V_{GS}=10V, I_D=50A$	-	5.5	7	$m\Omega$
Gate resistance	R_g	$V_{DS}=0V, V_{GS}=0V, f=1\text{MHz}$	-	1.2	-	Ω
Diode forward voltage	V_{SD}^1	$I_{SD}=50A, V_{GS}=0V$	-	0.88	1.3	V
Diode continuous forward current	I_S^3		-	-	50	A
Reverse recovery time	t_{rr}	$I_{SD}=70A, V_{DD}=50V,$ $di_{SD}/dt=100A/\mu s$	-	15.2	-	nS
Reverse recovery charge	Q_{rr}		-	6.16	-	nC
Input capacitance	C_{iss}	$V_{DS}=25V, V_{GS}=0V,$ $f=1\text{MHz}$	-	3100	-	μF
Output capacitance	C_{oss}		-	926	-	
Reverse transfer capacitance	C_{rss}		-	451	-	
Turn-on delay time	$t_{d(on)}$	$V_{DD}=30V, I_D=70A,$ $R_G=25\Omega, V_{GS}=10V$	-	20	-	ns
Rise time	t_r		-	83.7	-	
Turn-off delay time	$t_{d(off)}$		-	108	-	
Fall time	t_f		-	92.6	-	
Total gate charge	Q_g	$V_{DS}=50V, V_{GS}=10V$ $I_D=70A$	-	66.34	-	nC
Gate-source charge	Q_{gs}		-	12.35	--	
Gate-drain charge	Q_{gd}		-	33.52	--	

Note:1. Pulse test; pulse width $\leq 300\mu s$ duty cycle $\leq 2\%$.

2. Guaranteed by design, not subject to production testing.

3. Package limitation current is 50A. Calculated continuous current based on maximum allowable junction temperature.

4. Repetitive rating, pulse width limited by max junction temperature.

5. Starting $T_J=25^{\circ}\text{C}, L=0.4\text{mH}, I_{AS}=50A$.

7. Test circuits and waveforms

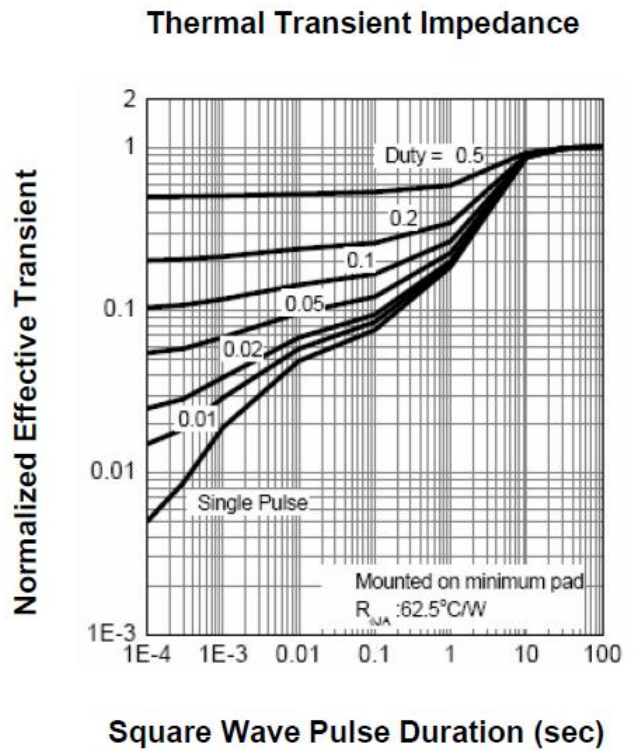
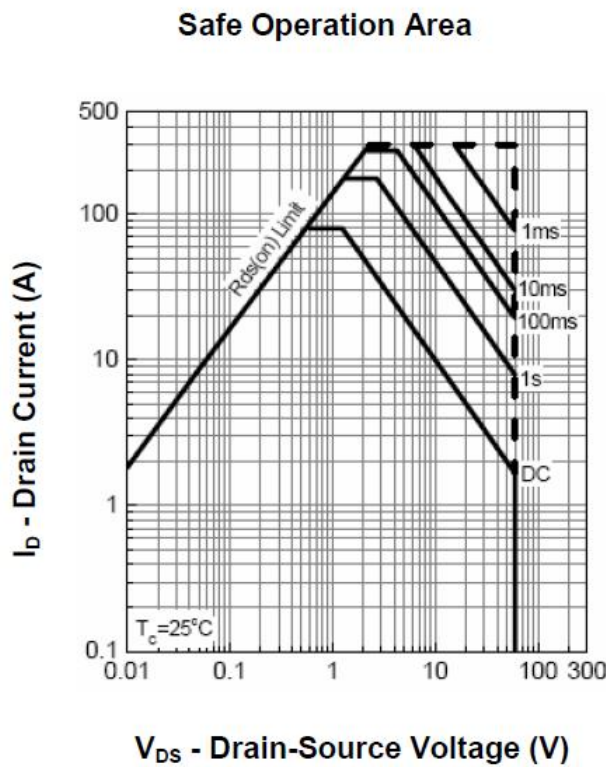
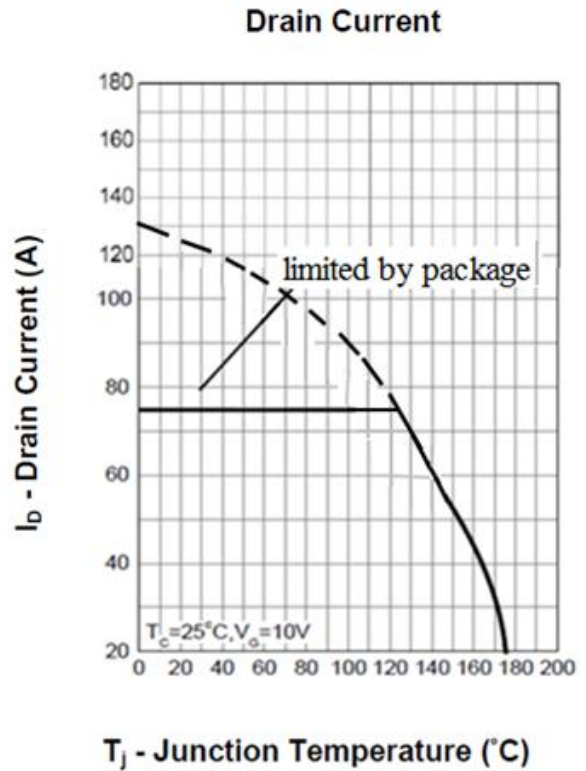
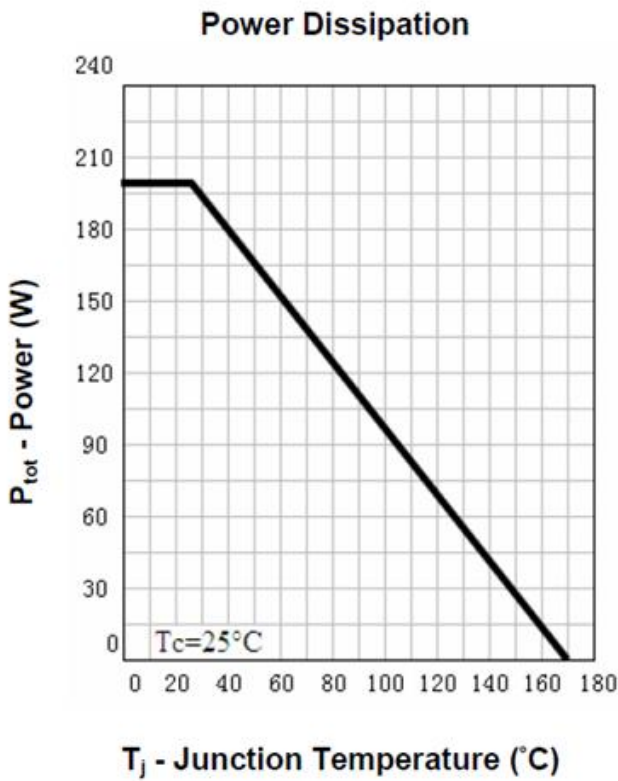

Output Characteristics

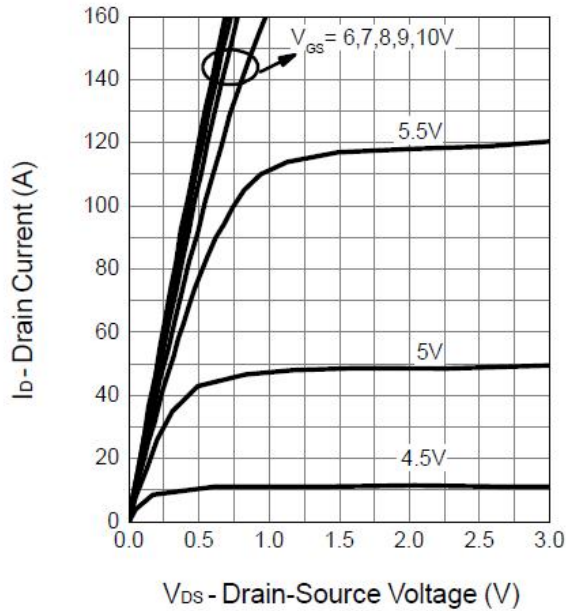

Drain-Source On Resistance

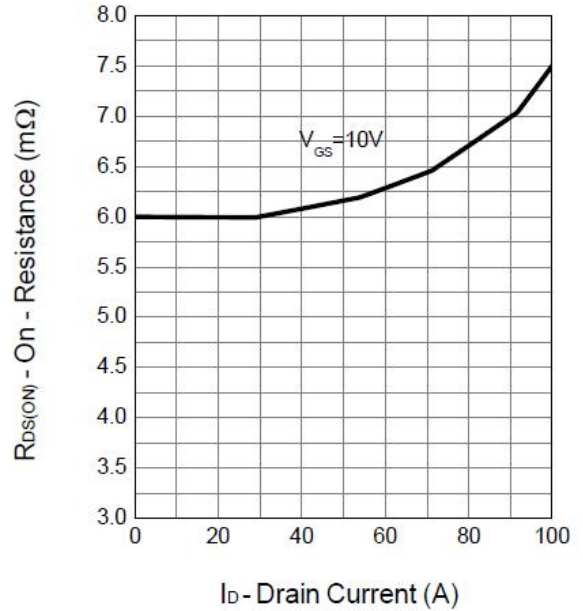

Drain-Source On Resistance

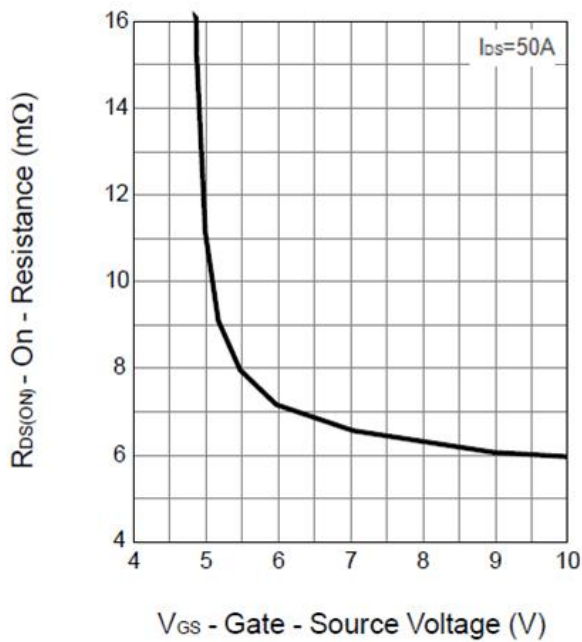

Gate Threshold Voltage

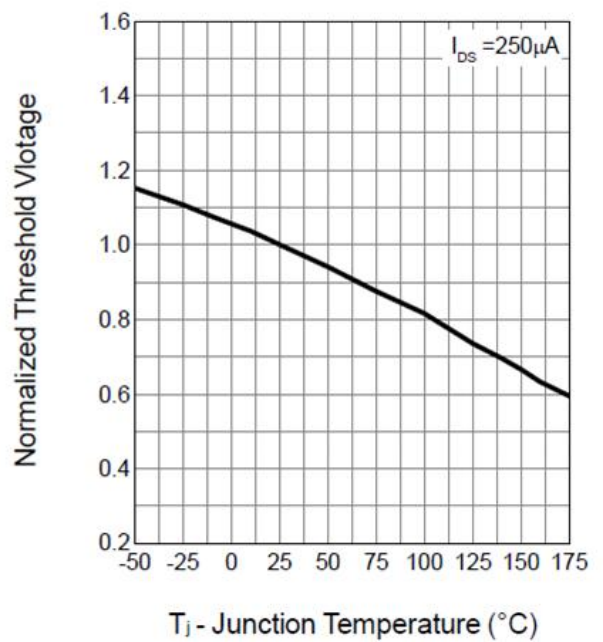

Drain-Source On Resistance

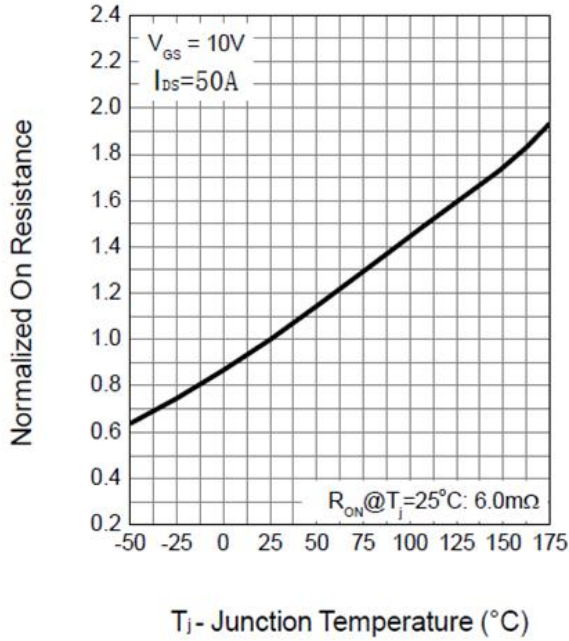

Source-Drain Diode Forward

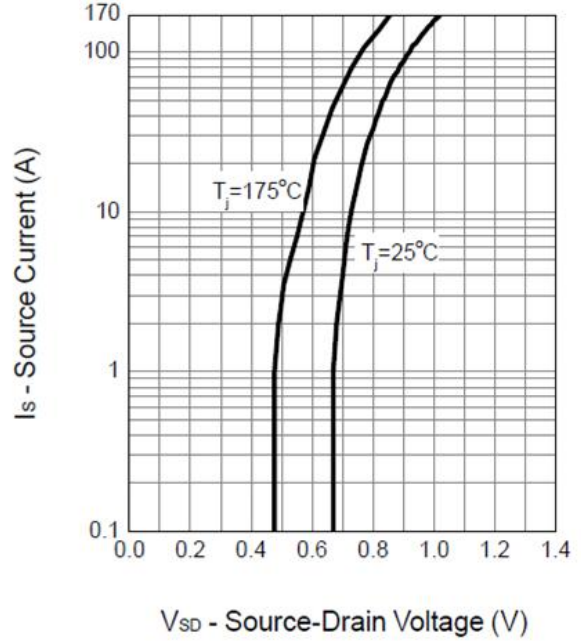

Capacitance

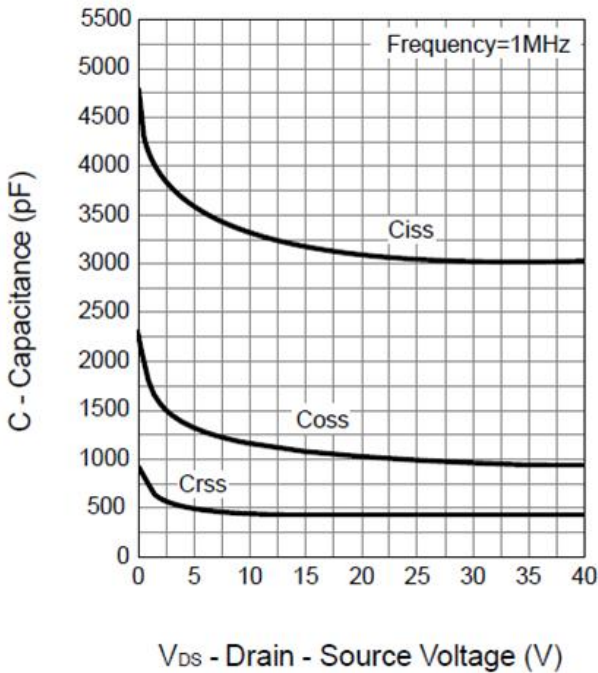

Gate Charge

