

P/N LEGEND

- F0500 WR-S-XP N L N XX X B0 R
 ① ② ③ ④ ⑤ ⑥ ⑦ ⑧ ⑨ ⑩ ⑪
- ① Series No.
 - ② Connector type: WR=Right angle
 - ③ Mounting type: S=SMT without boss
 - ④ No. of circuits
 - ⑤ N=Halogen Free
 - ⑥ Material: L=LCP
 - ⑦ Color: N=Natural(Beige)
 - ⑧ Plating code for contacts:
G1=Gold-flash/G2=Gold-Plated 3u"
T1=Matte Tin-plated
 - ⑨ Plating code for solder tabs:
G=Gold-flash; T=Matte Tin-plated
 - ⑩ Option code: B0=Bottom contact style
 - ⑪ Packing code: R=Tape & Reel

SPECIFICATIONS

Current Rating: 0.5A AC,DC
 Voltage Rating: 50V AC,DC
 Temperature Range: -25°C ~ +85°C
 Contact Resistance: 30mΩ Max.
 Insulation Resistance: 100MΩ Min.
 Withstanding Voltage: 250V AC/minute
 Contacts: Phosphor Bronze/Gold-flash or Matte Tin-plated
 Solder Tabs: Brass/Gold-flash or Matte Tin-plated
 Housing: LCP,UL94V-0,Natural(Beige)
 Actuator: Nylon 6T,UL94V-0,Natural(Black)

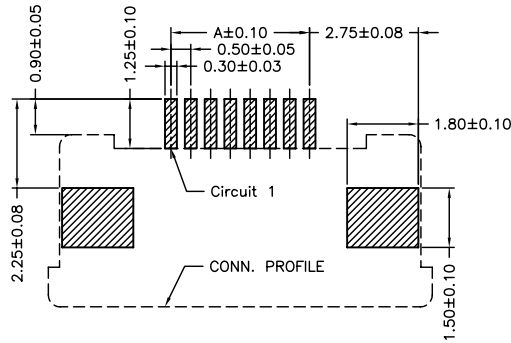

SUGGESTED PCB LAYOUT
(COMPONENT SIDE)

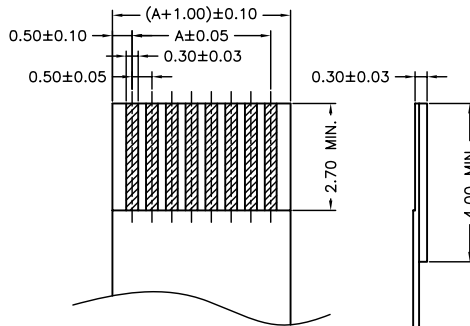

RECOMMENDED FFC/FPC DIMENSION

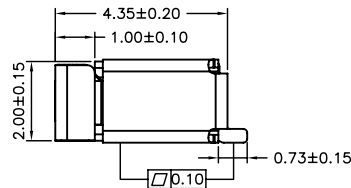
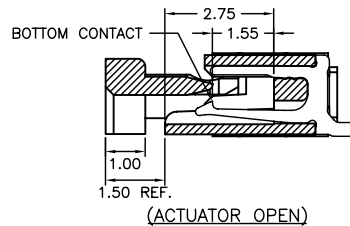
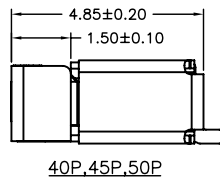
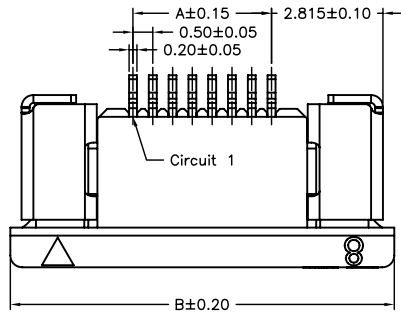

Circuit No.	Dimensions				Circuit No.	Dimensions			
	A	B	C	D		A	B	C	D
04P	1.50	7.70	2.60	0.300	25P	12.00	18.20	13.10	0.350
05P	2.00	8.20	3.10	0.300	26P	12.50	18.70	13.60	0.350
06P	2.50	8.70	3.60	0.300	27P	13.00	19.20	14.10	0.350
07P	3.00	9.20	4.10	0.350	28P	13.50	19.70	14.60	0.350
08P	3.50	9.70	4.60	0.350	29P	14.00	20.20	15.10	0.350
09P	4.00	10.20	5.10	0.350	30P	14.50	20.70	15.60	0.350
10P	4.50	10.70	5.60	0.350	31P	15.00	21.20	16.10	0.350
11P	5.00	11.20	6.10	0.350	32P	15.50	21.70	16.60	0.350
12P	5.50	11.70	6.60	0.350	33P	16.00	22.20	17.10	0.350
13P	6.00	12.20	7.10	0.350	34P	16.50	22.70	17.60	0.350
14P	6.50	12.70	7.60	0.350	35P	17.00	23.20	18.10	0.350
15P	7.00	13.20	8.10	0.350	36P	17.50	23.70	18.60	0.350
16P	7.50	13.70	8.60	0.350	37P	18.00	24.20	19.10	0.350
17P	8.00	14.20	9.10	0.350	38P	18.50	24.70	19.60	0.350
18P	8.50	14.70	9.60	0.350	39P	19.00	25.20	20.10	0.350
19P	9.00	15.20	10.10	0.350	40P	19.50	25.70	20.60	0.350
20P	9.50	15.70	10.60	0.350	45P	22.00	28.20	23.10	0.350
21P	10.00	16.20	11.10	0.350	49P	24.00	30.20	25.60	0.350
22P	10.50	16.70	11.60	0.350	50P	24.50	30.70	25.60	0.350
23P	11.00	17.20	12.10	0.350	51P	25.00	31.20	26.10	0.350
24P	11.50	17.70	12.60	0.350					



燦達電子工業股份有限公司
 JOINT TECH ELECTRONIC IND. CO., LTD.

UNIT	SCALE	SHEET
mm	1 : 1	1 of 2
DRAWN BY	APPROVED BY	
權生新	董正一	
2012.08.01	2012.08.01	
GENERAL TOLERANCE		
A1	EN1304240129	2013.04.10 郭本思
A0	NEW RELEASE	2012.08.01 權生新
REV.	DESCRIPTION	DATE NAME
X.X±0.25	ANGLE±	
X.XX±0.15		
X.XXX±0.05		

TITLE:
 0.50mm PITCH
 FFC/FPC CONNECTOR
 90° SMT TYPE, ZIF,
 BOTTOM CONTACT STYLE

DRAW NO.: F0500WR-S-XPXXXXXXBOX REV. A1



04~21 Contacts

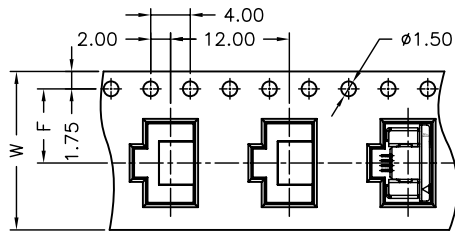

Unreeling direction →

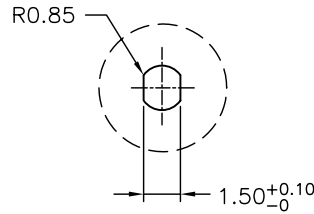
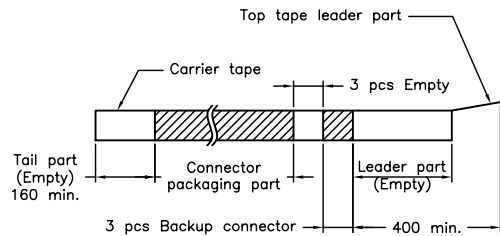
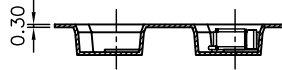

22~51 Contacts

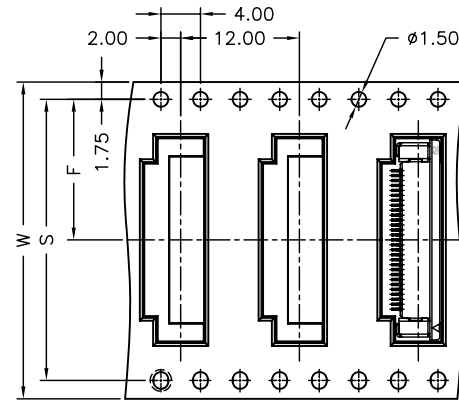

Unreeling direction →

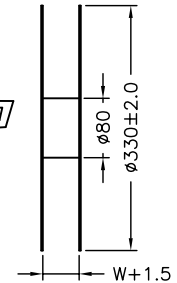
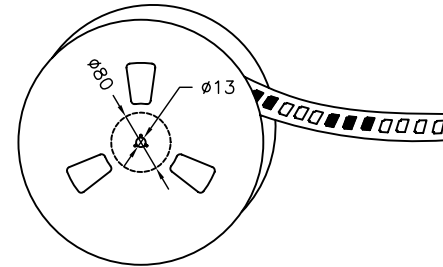
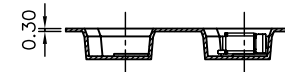

Number of Contacts	W±0.3	F±0.1	S±0.1	Q'ty/Reel	Number of Contacts	W±0.3	F±0.1	S±0.1	Q'ty/Reel
04P	16	7.50	28.40	1,500	25P	32	14.20	28.40	1,500
05P	16	7.50		26P	32	14.20	28.40	1,500	
06P	24	11.50		27P	32	14.20	28.40	1,500	
07P	24	11.50		28P	32	14.20	28.40	1,500	
08P	24	11.50		29P	32	14.20	28.40	1,500	
09P	24	11.50		30P	32	14.20	28.40	1,500	
10P	24	11.50		31P	44	20.20	40.40	1,500	
11P	24	11.50		32P	44	20.20	40.40	1,500	
12P	24	11.50		33P	44	20.20	40.40	1,500	
13P	24	11.50		34P	44	20.20	40.40	1,500	
14P	24	11.50		35P	44	20.20	40.40	1,500	
15P	24	11.50		36P	44	20.20	40.40	1,500	
16P	24	11.50		37P	44	20.20	40.40	1,500	
17P	24	11.50		38P	44	20.20	40.40	1,500	
18P	24	11.50		39P	44	20.20	40.40	1,500	
19P	24	11.50		40P	44	20.20	40.40	1,500	
20P	24	11.50		45P	44	20.20	40.40	1,500	
21P	24	11.50		49P	44	20.20	40.40	1,500	
22P	32	14.20		50P	44	20.20	40.40	1,500	
23P	32	14.20		51P	44	20.20	40.40	1,500	
24P	32	14.20							

				燦達電子工業股份有限公司 JOINT TECH ELECTRONIC IND. CO., LTD.	
UNIT		SCALE	SHEET		TITLE:
mm		1 : 1	2 of 2		
DRAWN BY		APPROVED BY			
權生新		董正一			
2012.08.01		2012.08.01		0.50mm PITCH FFC/FPC CONNECTOR 90°SMT TYPE, ZIF, BOTTOM CONTACT STYLE, TAPING SPEC.	
GENERAL TOLERANCE					
A1	EN1304240129	2013.04.10	郭本思		X.X±0.25
A0	NEW RELEASE	2012.08.01	權生新		X.XX±0.15
REV.	DESCRIPTION	DATE	NAME	X.XXX±0.05	ANGLE±
DRAW NO. : F0500WR-S-XPXXXXXXBOX					REV. A1