

Specification for Approval

Date: 2013/06/14

Customer : _____

TAI-TECH P/N: DFP252012NF-SERIES

CUSTOMER P/N: _____

DESCRIPTION: _____

QUANTITY: _____ pcs

REMARK:		
Customer Approval Feedback		

西北臺慶科技股份有限公司
TAI-TECH Advanced Electronics Co., Ltd

西北臺慶科技股份有限公司
 TAI-TECH Advanced Electronics Co., Ltd
 Headquarter:
 NO.1 YOU 4TH ROAD, YOUTH INDUSTRIAL DISTRICT, YANG-MEI,
 TAO-YUAN HSIEN, TAIWAN, R.O.C.
 TEL: +886-3-4641148 FAX: +886-3-4643565
 http://www.tai-tech.com.tw
 E-mail: sales@tai-tech.com.tw

東莞臺慶精密電子有限公司
 DONGGUAN TAI-TECH ADVANCED ELECTRONICS CO., LTD
 JITIGANG MANAGEMENT DISTRICT, HUANGJIANG, DONGGUAN,
 GUANGDONG, CHINA
 TEL: +86-769-3365488 FAX: +86-769-3366896
 E-mail: twnwe@pub.dgnet.gd.cn

Office:
 金亨國際有限公司
 KAMHENG INTERNATIONAL LIMITED
 TEL: +86-852-25772033 FAX: +86-852-28817778

臺慶精密電子(昆山)有限公司
 TAI-TECH ADVANCED ELECTRONICS(KUNSHAN) CO., LTD
 SHINWHA ROAD, KUNJIA HI-TECH INDUSTRIAL PARK, KUN-SHAN,
 JIANG-SU, CHINA
 TEL: +86-512-57619396 FAX: +86-512-57619688
 E-mail: hui@tai-tech.com.tw

Office:
 北欣國際有限公司
 NORTH STAR INTERNATIONAL LIMITED
 TEL: +86-512-57619396 FAX: +86-512-57619688

Sales Dep.

APPROVED	CHECKED
楊登欽 Peter Yang	姜佩蓉 Pei-Rong Chiang

R&D Center

APPROVED	CHECKED	DRAWN
楊祥忠 Mikey Yang	詹偉特 Jack Chan	林宜蕙 Beryl Lin

Power Inductor

DFP252012NF-SERIES

ECN HISTORY LIST

REV	DATE	DESCRIPTION	APPROVED	CHECKED	DRAWN
1.0	13/06/14	新發行	楊祥忠	詹偉特	林宜蒨
備 註					

Power Inductor

DFPUHP252012NF-SERIES

1. Features

1. This specification applies Low Profile Power Inductors.
2. 100% Lead(Pb) & Halogen-Free and RoHS compliant.



2. Dimension

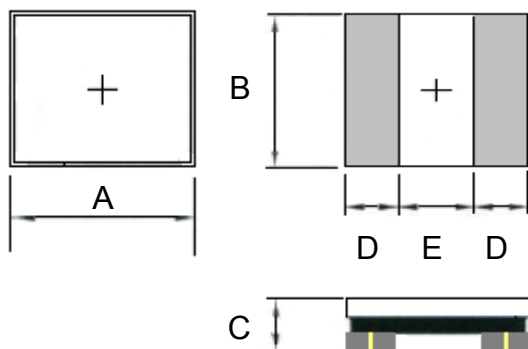

Series	A(mm)	B(mm)	C(mm)	D(mm)	E(mm)
DFP252012NF	2.5 -0.1/+0.3	2.0 -0.05/+0.35	1.2 max.	0.85 ref.	0.80 ref.

Units: mm

3. Part Numbering

DFP
252012
NF
-
R47
M

A: Series
 B: Dimension
 C: Lead Free Material
 D: Inductance R47=0.47uH
 E: Inductance Tolerance M=±20%

4. Specification

TAI-TECH Part Number	Inductance (uH)	Tolerance (%)	Test Frequency (Hz)	DCR (Ω) typ.	DCR (Ω) Max.	I sat (A) typ.	I sat (A) Max.	I rms (A) typ	I rms (A) Max.
DFP252012NF-R47M	0.47	±20%	0.1V/1M	0.029	0.039	4.70	3.80	3.90	3.30
DFP252012NF-R68M	0.68	±20%	0.1V/1M	0.042	0.055	4.40	3.70	3.50	2.90
DFP252012NF-1R0M	1.0	±20%	0.1V/1M	0.047	0.062	3.80	3.00	3.00	2.70

Note:

Isat : Based on inductance change (ΔL/L0 : ≤-30%) @ ambient temp. 25°C

Irms : Based on temperature rise (ΔT : 40°C.)

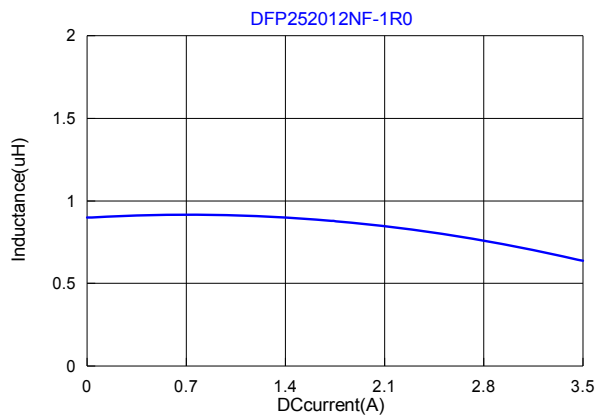
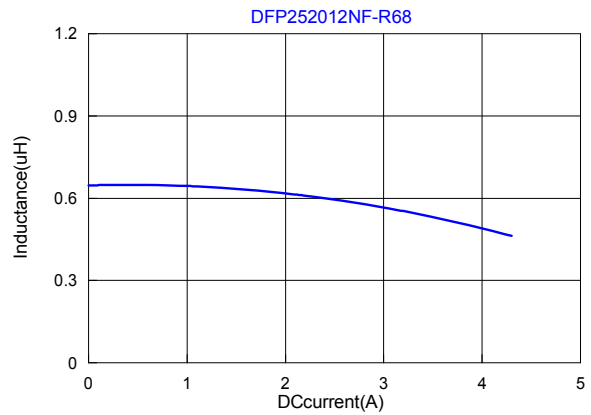
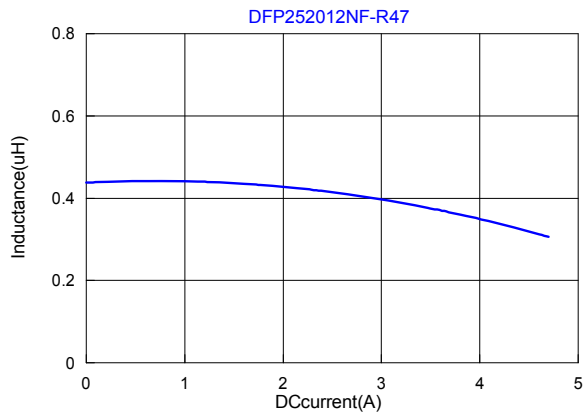

5. Material List

No.	Description	Specification
a.	Core	Ferrite Core
b.	Coating	Epoxy with magnetic powder
c.	Termination	Tin Pb Free
d.	Wire	Enameled Copper Wire

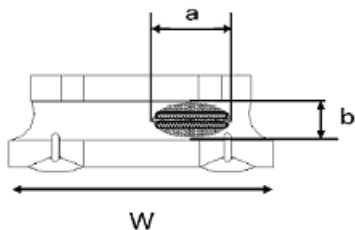
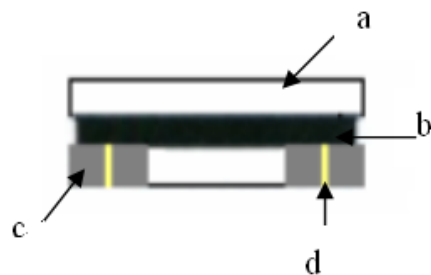

Exposed wire tolerance limit of coating resin part on product side.

Size of exposed wire occurring to coating resin is specified below.

1. Width direction (dimension a) : Acceptable when $a \leq w/2$
Nonconforming when $a > w/2$
2. Length direction (dimension b) : Dimension b is not specified.
3. The total area of exposed wire occurring to each sides is not greater than 50% of coating resin area, and is acceptable.

6. Reliability and Test Condition

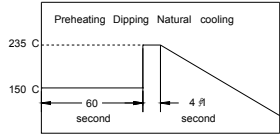
Item	Performance	Test Condition												
Operating Temperature	-40~+85°C (For products in unopened tape package, less than 40°C)													
Electrical Performance Test														
Inductance L	Refer to standard electrical characteristic list	Agilent-4291, Agilent-4287												
Q		Agilent-4192, Agilent-4285												
SRF		Agilent-4291												
DC Resistance		Agilent-4338												
Rated Current	Base on temp. rise & $\Delta L/L_{OA} \leq 30\%$.	Saturation DC Current (Isat) will cause L0 to drop approximately $\Delta L(\%)$.												
Temperature Rise Test	ΔT 40°C Max	Heat Rated Current (Irms) will cause the coil temperature rise approximately $\Delta T(^{\circ}C)$ without core loss. 1.Applied the allowed DC current. 2.Temperature measured by digital surface thermometer												
Mechanical Performance Test														
Resistance to Soldering Heat MIL-STD-202 METHOD 210	1. Inductors shall be no evidence of electrical and mechanical damage. 2. Inductance : within $\pm 10\%$ of initial value	Temp.: 260 $\pm 5^{\circ}C$ Time: 10 ± 1.0 Sec												
Solderability Test ANSI/J-STD-002	More than 95% of terminal electrode should be covered with solder.	 <p>After fluxing, component shall be dipped in a melted solder bath at 235$\pm 5^{\circ}C$ for 4± 1seconds.</p>												
Reliability Test														
Humidity Test MIL-STD-202 METHOD 103	1. Visual examination : No mechanical damage 2. Inductance : within $\pm 10\%$ of initial value	1. Temperature : 40 $\pm 2^{\circ}C$ 2. Humidity : 90 ~ 95% 3. Time : 500 ± 8 hrs 4. Measured at room temperature after placing for 2 to 3 hrs												
Thermal Shock Test MIL-STD-202 METHOD 107	1. Visual examination : No mechanical damage 2. Inductance : within $\pm 10\%$ of initial value	Conditions for 1 cycle <table border="1" data-bbox="1129 1473 1417 1615"> <thead> <tr> <th>Step</th> <th>Temperature($^{\circ}C$)</th> <th>Times(min.)</th> </tr> </thead> <tbody> <tr> <td>1</td> <td>-55± 2</td> <td>30± 3</td> </tr> <tr> <td>2</td> <td>Room Temperature</td> <td>Within 5</td> </tr> <tr> <td>2</td> <td>85± 5</td> <td>30± 3</td> </tr> </tbody> </table> Total: 100 cycles Measured at room temperature after placing for 2 to 3 hrs	Step	Temperature($^{\circ}C$)	Times(min.)	1	-55 ± 2	30 ± 3	2	Room Temperature	Within 5	2	85 ± 5	30 ± 3
Step		Temperature($^{\circ}C$)	Times(min.)											
1		-55 ± 2	30 ± 3											
2		Room Temperature	Within 5											
2		85 ± 5	30 ± 3											
High Temperature Life Test MIL-STD-202 METHOD 108	1. Temperature : 85 $\pm 2^{\circ}C$ 2. Time : 500 ± 8 hrs 3. Measured at room temperature after placing for 2 to 3 hrs													
Humidity Resistance Test MIL-STD-202 METHOD 103	1. Temperature: 40 $\pm 2^{\circ}C$ 2. Humidity: 90~ 95% 3. Time: 500 ± 8 hr. 4. Recovery: 2 to 3hrs of recovery under the standard condition after the removal from test chamber.													
Low temperature Storage Test JESD22-A119	1. Temperature : -40 $\pm 2^{\circ}C$ 2. Time : 500 ± 8 hrs 3. Measured at room temperature after placing for 2 to 3 hrs													

Item	Performance	Test Condition
Random Vibration Test MIL-STD-202 Method 204	Appearance: Cracking, shipping and any other defects harmful to the characteristics should not be allowed. Impedance: within±30%	Frequency: 10-55-10Hz for 15 min. Amplitude: 1.52mm Directions and times: X, Y, Z directions for 15 min. This cycle shall be performed 12 times in each of three mutually perpendicular directions (Total 9hours).

7. Soldering and Mounting

7-1. Soldering

Mildly activated rosin fluxes are preferred. TAI-TECH terminations are suitable for all wave and re-flow soldering systems. If hand soldering cannot be avoided, the preferred technique is the utilization of hot air soldering tools.

7-1.1 Solder re-flow:

Recommended temperature profiles for re-flow soldering in Figure 1.

7-1.2 Soldering Iron(Figure 2):

Products attachment with a soldering iron is discouraged due to the inherent process control limitations. In the event that a soldering iron must be employed the following precautions are recommended.

- Preheat circuit and products to 150°C
- Never contact the ceramic with the iron tip
- Use a 20 watt soldering iron with tip diameter of 1.0mm
- 355°C tip temperature (max)
- 1.0mm tip diameter (max)
- Limit soldering time to 4~5 sec.

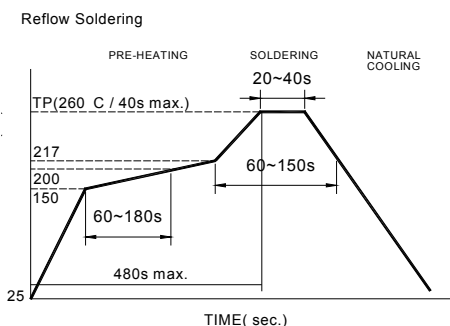

Reflow times: 3 times max.

Fig.1

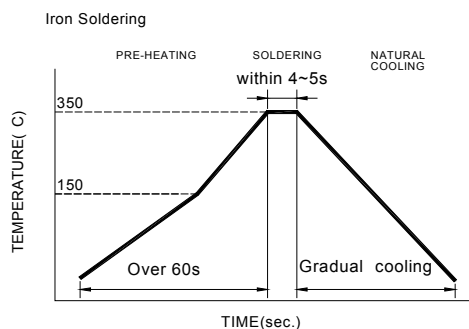

Iron Soldering times: 1 times max.

Fig.2

7-2. Recommended PC Board Pattern

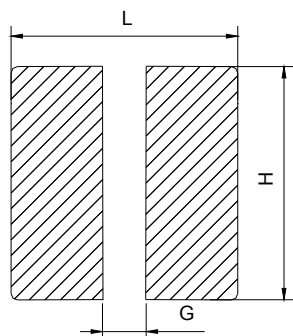

L(mm)	G(mm)	H(mm)
2.9	0.8	2.4

8. Packaging Information

8-1. Reel Dimension

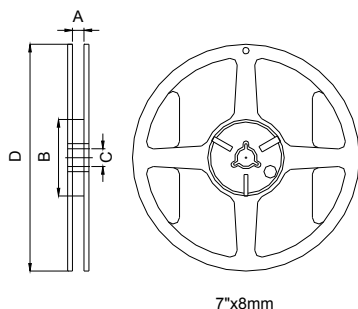

Type	A(mm)	B(mm)	C(mm)	D(mm)
7"x8mm	8.4±1.0	50 min.	13±0.8	178±2

8-2. Tape Dimension / 8mm

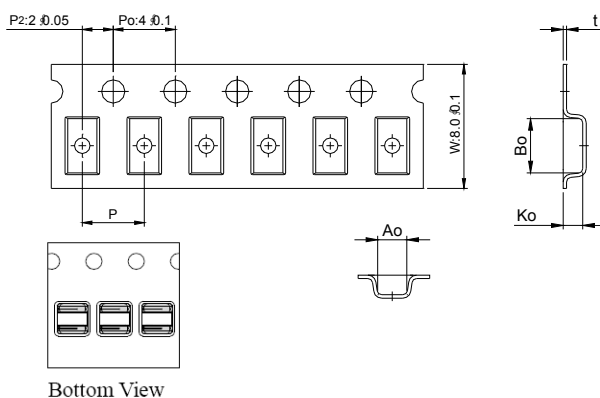

Series	Size	Bo(mm)	Ao(mm)	Ko(mm)	P(mm)	t(mm)
DFP	252012	3.10±0.1	2.45±0.1	1.40±0.1	4.0±0.1	0.23±0.05

8-3. Packaging Quantity

Chip size	252012
Chip / Reel	2000

8-4. Tearing Off Force

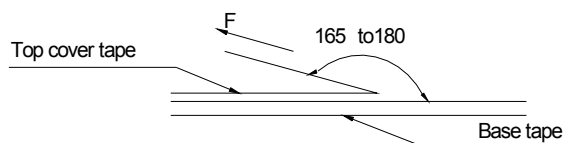

The force for tearing off cover tape is 15 to 80 grams in the arrow direction under the following conditions.

Room Temp. (°C)	Room Humidity (%)	Room atm (hPa)	Tearing Speed mm/min
5~35	45~85	860~1060	300

Application Notice

- Storage Conditions

To maintain the solderability of terminal electrodes:

1. TAI-TECH products meet IPC/JEDEC J-STD-020D standard-MSL, level 1.
2. Temperature and humidity conditions: Less than 40°C and 60% RH.
3. Recommended products should be used within 12 months from the time of delivery.
4. The packaging material should be kept where no chlorine or sulfur exists in the air.

- Transportation

1. Products should be handled with care to avoid damage or contamination from perspiration and skin oils.
2. The use of tweezers or vacuum pick up is strongly recommended for individual components.
3. Bulk handling should ensure that abrasion and mechanical shock are minimized.