

Kyocera's series of Multilayer Ceramic Chip Capacitors are designed to meet a wide variety of needs. We offer a complete range of products for both general and specialized applications, including CM series for general-purpose, CT series for low profile, CA series for arrays, CL series for ICs, CF series for high-voltage, and DM series for automotive.

Features

- We have factories worldwide in order to supply our global customer bases quickly and efficiently and to maintain our reputation as one of the highest-volume producers in the industry.
- All our products are highly reliable due to their monolithic structure of high-purity and superfine uniform ceramics and their integral internal electrodes.
- By combining superior manufacturing technology and materials with high dielectric constants, we produce extremely compact components with exceptional specifications.
- Our stringent quality control in every phase of production from material procurement to shipping ensures consistent manufacturing and super quality.
- Kyocera components are available in a wide choice of dimensions, temperature characteristics, rated voltages, and terminations to meet specific configurational requirements.

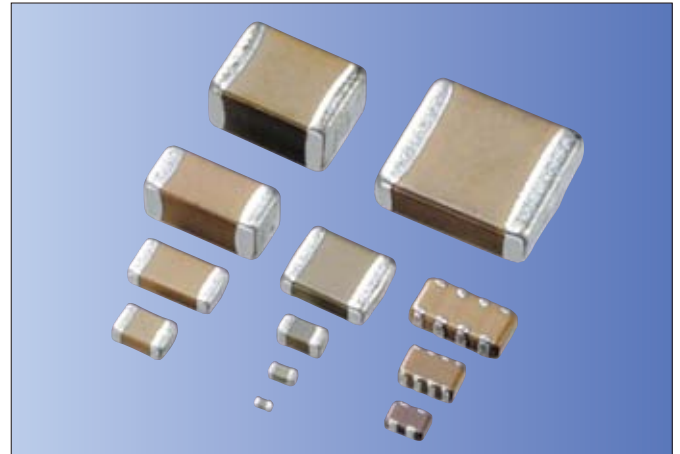

RoHS Compliant

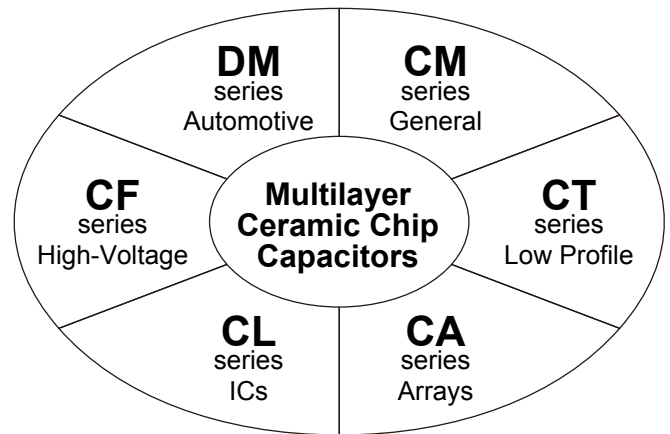

Structure

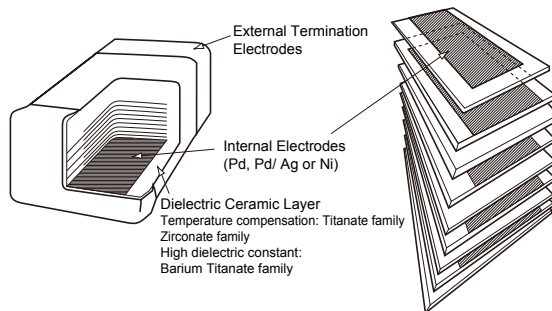

Nickel Barrier Termination Products

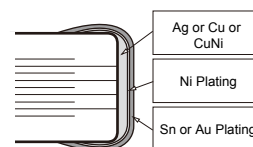

Tape and Reel

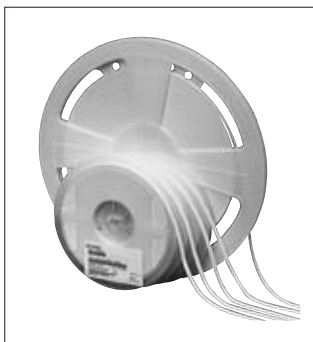

Bulk Case

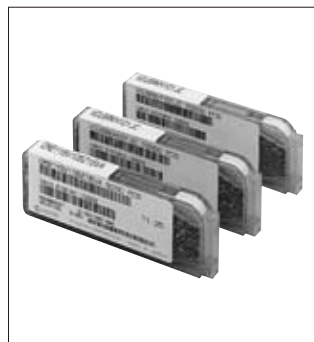

Please contact your local AVX, Kyocera sales office or distributor for specifications not covered in this catalog.

Our products are continually being improved. As a result, the capacitance range of each series is subject to change without notice. Please contact an sales representative to confirm compatibility with your application.

Kyocera Ceramic Chip Capacitors are available for different applications as classified below:

Series	Dielectric Options	Typical Applications	Features	Terminations	Available Size
CM	C0G (NP0) X5R X7R *X6S *X7S Y5V	General purpose	Wide cap range	Nickel barrier	01005, 0201, 0402 0603, 0805, 1206 1210, 1812
CT	X5R X7R Y5V	IC card (Decoupling)	Low profile	Nickel barrier	0201, 0402, 0603 0805, 1206, 1210
CA	C0G (NP0) X5R, X7R	Digital signal Pass line	Reduction in placing cost	Nickel barrier	0405, 0508
CL	X7S	ICs (Decoupling)	Low inductance	Nickel barrier	0204, 0306
CF	C0G (NP0) X7R	High voltage & Power circuits	High voltage 250VDC, 630VDC 1000VDC, 2000VDC 3000VDC, 4000VDC	Nickel barrier	0805, 1206, 1210 1812, 2208, 1808 2220
DM	X7R	Automotive	Thermal shock Resistivity High reliability	Nickel barrier	0603,0805,1206

* Option

* Negative temperature coefficient dielectric types are available on request.

Dimensions

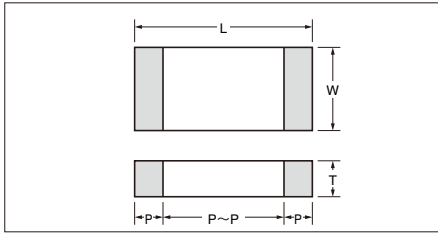

Dimensions and Packaging Quantities

Size	Code		Dimension Code	Dimensions (mm)						Maximum quantity per reel			
	JIS	EIA		L	W	T	P min.	P max.	P to P min.	φ180 Reel	φ330 Reel		
02	0402	01005	A	0.4±0.02	0.2±0.02	0.2±0.02	0.07	0.14	0.13	40kp (P8/1) 20kp (P8/2)	— 50kp (P8/2)		
03	0603	0201	A	0.6±0.03	0.3±0.03	0.22 max.	0.10	0.20	0.20	35kp (P8/1) 15kp (P8/2)	— 50kp (P8/2)		
			B			0.3±0.03				35kp (P8/1) 15kp (P8/2)	— 50kp (P8/2)		
			C	0.6±0.05	0.3±0.05	0.3±0.05	0.13	0.23	0.19	35kp (P8/1) 15kp (P8/2)	— 50kp (P8/2)		
05	1005	0402	A	1.0±0.05	0.5±0.05	0.25 max.	0.15	0.35	0.30	30kp (P8/1) 10kp (P8/2)	— 50kp (P8/2)		
			B			0.35 max.				30kp (P8/1) 10kp (P8/2)	— 50kp (P8/2)		
			C			0.5±0.05				30kp (P8/1) 10kp (P8/2)	— 50kp (P8/2)		
			D	1.0±0.10	0.5±0.10	0.35 max.				30kp (P8/1) 10kp (P8/2)	— 50kp (P8/2)		
			E			0.5±0.10				30kp (P8/1) 10kp (P8/2)	— 50kp (P8/2)		
			F			1.0±0.15				0.5±0.15	0.5±0.15	30kp (P8/1) 10kp (P8/2)	— 50kp (P8/2)
105	1608	0603	A	1.6±0.10	0.8±0.10	0.55 max.	0.20	0.60	0.50	4kp (P8/4) 8kp (P8/2) 4kp (P8/4)	10kp (P8/4) 20kp (P8/2) 10kp (P8/4)		
			B			0.8±0.10				8kp (P8/2) 4kp (P8/4)	20kp (P8/2) 10kp (P8/4)		
			C	1.6±0.15	0.8±0.15	0.55 max.				8kp (P8/2) 4kp (P8/4)	20kp (P8/2) 10kp (P8/4)		
			D			0.8±0.15				8kp (P8/2) 4kp (P8/4)	20kp (P8/2) 10kp (P8/4)		
			E	1.6±0.2	0.8±0.2	0.55 max.				8kp (P8/2) 4kp (P8/4)	20kp (P8/2) 10kp (P8/4)		
21	2012	0805	A	2.0±0.10	1.25±0.10	0.55 max.	0.20	0.75	0.70	4kp (P8/4) 4kp (P8/4) 4kp (E8/4)	10kp (P8/4) 10kp (P8/4) 10kp (E8/4)		
			B			0.95 max.				4kp (P8/4) 4kp (E8/4)	10kp (P8/4) 10kp (E8/4)		
			C			1.00 max.				4kp (P8/4) 4kp (E8/4)	10kp (P8/4) 10kp (E8/4)		
			D			0.6±0.10				4kp (P8/4) 4kp (E8/4)	10kp (P8/4) 10kp (E8/4)		
			E			0.85±0.10				4kp (P8/4) 4kp (E8/4)	10kp (P8/4) 10kp (E8/4)		
			F			1.05±0.10				3kp (E8/4) 3kp (E8/4)	10kp (E8/4) 10kp (E8/4)		
			G			1.25±0.10				3kp (E8/4) 3kp (E8/4)	10kp (E8/4) 10kp (E8/4)		
			H	2.0±0.15	1.25±0.15	0.55 max.				4kp (P8/4) 4kp (P8/4)	10kp (P8/4) 10kp (P8/4)		
			J			0.95 max.				4kp (P8/4) 4kp (P8/4)	10kp (P8/4) 10kp (P8/4)		
			K			1.25±0.15				3kp (E8/4) 3kp (E8/4)	10kp (E8/4) 10kp (E8/4)		
			L			2.0±0.20				1.25±0.20	0.95 max.	4kp (P8/4) 3kp (E8/4)	10kp (P8/4) 10kp (E8/4)
			M								1.25±0.20	3kp (E8/4) 3kp (E8/4)	10kp (E8/4) 10kp (E8/4)
											0.85±0.10	4kp (P8/4) 4kp (P8/4) 4kp (E8/4)	10kp (P8/4) 10kp (P8/4) 10kp (E8/4)
316	3216	1206	A	3.2±0.20	1.6±0.15	0.85±0.10	0.30	0.85	1.40	4kp (P8/4) 4kp (P8/4) 4kp (E8/4)	10kp (P8/4) 10kp (P8/4) 10kp (E8/4)		
			B			0.95 max.				4kp (P8/4) 3kp (E8/4)	10kp (P8/4) 10kp (E8/4)		
			C			1.00 max.				4kp (E8/4) 3kp (E8/4)	10kp (E8/4) 10kp (E8/4)		
			D			1.15±0.10				3kp (E8/4) 3kp (E8/4)	10kp (E8/4) 10kp (E8/4)		
			E			1.25±0.10				3kp (E8/4) 3kp (E8/4)	10kp (E8/4) 10kp (E8/4)		
			F	1.6±0.15	2.5kp (E8/4) 4kp (P8/4)	5kp (E8/4) 10kp (P8/4)							
			G	3.2±0.20	1.6±0.20	0.95 max.				4kp (E8/4) 2.5kp (E8/4)	10kp (E8/4) 5kp (E8/4)		
			H			1.00 max.				4kp (E8/4) 2.5kp (E8/4)	10kp (E8/4) 5kp (E8/4)		
			J			1.6±0.20				2.5kp (E8/4) 1kp (E8/4)	5kp (E8/4) 4kp (E8/4)		
	1.00 max.	4kp (E8/4) 3kp (E8/4)	10kp (E8/4) 10kp (E8/4)										
32	3225	1210	A	3.2±0.20	2.5±0.20	1.40 max.	0.30	1.00	1.40	4kp (E8/4) 3kp (E8/4) 2.5kp (E8/4)	10kp (E8/4) 10kp (E8/4) 5kp (E8/4)		
			B			1.60 max.				2.5kp (E8/4) 2.5kp (E8/4)	5kp (E8/4) 5kp (E8/4)		
			C			1.6±0.15				2.5kp (E8/4) 2.5kp (E8/4)	5kp (E8/4) 5kp (E8/4)		
			D			2.20 max.				2kp (E8/4) 2kp (E8/4)	5kp (E8/4) 5kp (E8/4)		
			E			2.0±0.2				2kp (E8/4) 1kp (E8/4)	5kp (E8/4) 4kp (E8/4)		
			F			2.5±0.2				1kp (E8/4)	4kp (E8/4)		
			G			4.5±0.20				2.0±0.20	1.6 max.	2kp (E12/4) 2kp (E12/4)	— —
											2.2 max.	2kp (E12/4)	—
43	4532	1812	A	4.5±0.30	3.2±0.20	2.0 max.	0.30	1.10	2.00	1kp (E12/4) 1kp (E12/4)	— —		
			B			2.0±0.2				1kp (E12/4)	—		
			C			2.5 max.				0.5kp (E12/4) 0.5kp (E12/4)	— —		
			D			2.5±0.2				0.5kp (E12/4) 0.5kp (E12/4)	— —		
			E			2.8 max.				0.5kp (E12/4) 0.5kp (E12/4)	— —		
			F			2.8±0.2				0.5kp (E12/4)	—		
52	5720	2208	A	5.7±0.40	2.0±0.20	2.2 max.	0.15	0.85	4.20	2kp (12/4)	—		
55	5750	2220	A	5.7±0.40	5.0±0.40	2.0 max.	0.30	1.40	2.50	1kp (E12/4)	—		
			B			2.5 max.				0.5kp (E12/4)	—		
			C			2.8 max.				0.5kp (E12/4)	—		

Note: Taping denotes the quantity packaged per reel (kp means 1000 pieces).

Multilayer Ceramic Chip Capacitors Ordering Information



KYOCERA PART NUMBER

CM 21 X7R 104 K 50 A T □ □ □

SERIES CODE

CM = General Purpose CL = ICs
 CT = Low Profile CF = High Voltage
 CA = Arrays DM = Automotive

SIZE CODE

SIZE	EIA	(JIS)	SIZE	EIA	(JIS)	SIZE	EIA	(JIS)			
02	=	01005	(0402)	32	=	1210	(3225)	D11	=	0405	(1014)/ 2 cap
03	=	0201	(0603)	42	=	1808	(4520)	F12	=	0508	(1220)/ 4 cap
05	=	0402	(1005)	43	=	1812	(4532)				
105	=	0603	(1608)	52	=	2208	(5720)				
21	=	0805	(2012)	55	=	2220	(5750)				
316	=	1206	(3216)								

DIELECTRIC CODE

CODE EIA CODE
 CG = C0G (NPO) X7S = X7S (Option)
 X5R = X5R X6S = X6S (Option)
 X7R = X7R Y5V = Y5V

Negative temperature coefficient dielectric types are available on request.

CAPACITANCE CODE

Capacitance expressed in pF.
 Two significant digits plus number of zeros.
 For Values < 10pF, Letter R denotes decimal point,
 eg. 100000pF = 104 1.5pF = 1R5
 0.1μF = 104 0.5pF = R50
 4700pF = 472 100μF = 107

TOLERANCE CODE

A = ±0.05pF (option) D = ±0.5pF J = ±5% Z = -20 to +80%
 B = ±0.1pF F = ±1pF K = ±10%
 C = ±0.25pF G = ±2% (option) M = ±20%

VOLTAGE CODE

04 = 4VDC	100 = 100VDC	1000 = 1000VDC
06 = 6.3VDC	250 = 250VDC	2000 = 2000VDC
10 = 10VDC	400 = 400VDC	3000 = 3000VDC
16 = 16VDC	630 = 630VDC	4000 = 4000VDC
25 = 25VDC		
35 = 35VDC		
50 = 50VDC		

TERMINATION CODE

A = Nickel Barrier/ Tin K = Nickel Barrier/ Au

PACKAGING CODE

B = Bulk	L = 13" Reel Taping & 4mm Cavity pitch
C = Bulk Cassette (option)	H = 7" Reel Taping & 2mm Cavity pitch
T = 7" Reel Taping & 4mm Cavity pitch	N = 13" Reel Taping & 2mm Cavity pitch
Q = 7" Reel Taping & 1mm Cavity pitch	

OPTION

Thickness max. value is indicated in CT series

EX. 125 → 1.25mm max.
 095 → 0.95mm max.

Temperature Compensation Type

Dielectric Value (pF)	C0G (NPO) 0 ppm/ °C	UΔ (N750) -750 ppm/ °C	SL +350 to -1000ppm/ °C
0.5 to 2.7	CK	UK	SL
3.0 to 3.9	CJ	UJ	SL
4.0 to 9.0	CH	UJ	SL
≥10	CG	UJ	SL

K = ±250ppm/ °C, J = ±120ppm/ °C, H = ±60ppm/ °C, G = ±30ppm/ °C
e.g. CG = 0±30ppm/ °C

Note: All parts of C0G will be marked as "CG" but will conform to the above table.

High Dielectric Constant Type

EIA Dielectric	Temperature Range	ΔC max.
X5R	-55 to 85°C	±15%
X7R	-55 to 125°C	
*X7S	-55 to 125°C	±22%
*X6S	-55 to 105°C	
Y5V	-30 to 85°C	-82 to +22%

* option

Available Tolerances

Dielectric materials, capacitance values and tolerances are available in the following combinations only:

EIA Dielectric	Tolerance	Capacitance
C0G	C=±0.25pF D=±0.50pF F=±1pF	*1 <10pF
	*3 A=±0.05pF B=±0.1pF	<0.5pF ≤5pF
	*3 G=±2% J=±5% K=±10%	≥10pF E12 Series
*3 X6S X5R *3 X7S X7R	*2 K=±10% M=±20%	*4 E3 Series
Y5V	Z=-20% to +80%	E3 Series

Note:

*1 Nominal values below 10pF are available in the standard values of 0.5pF, 1.0pF, 1.5pF, 2.0pF, 3.0pF, 4.0pF, 5.0pF, 6.0pF, 7.0pF, 8.0pF, 9.0pF

*2 J = ±5% for X7R (X5R) is available on request.

*3 option

*4 E6 series is available on request.

E Standard Number

E3	E6	E12	E24 (Option)		
1.0	1.0	1.0	1.0	1.1	
		1.2	1.2	1.3	
	1.5	1.5	1.5	1.6	
		1.8	1.8	2.0	
2.2	2.2	2.2	2.2	2.4	
		2.7	2.7	3.0	
	3.3	3.3	3.3	3.6	
		3.9	3.9	4.3	
	4.7	4.7	4.7	4.7	5.1
			5.6	5.6	6.2
6.8		6.8	6.8	7.5	
		8.2	8.2	9.1	

Features

We offer a diverse product line ranging from ultra-compact (0.4×0.2mm) to large (4.5×3.2mm) components configured for a variety of temperature characteristics, rated voltages, and packages. We offer the choice and flexibility for almost any applications.

Applications

This standard type is ideal for use in a wide range of applications, from commercial to industrial equipment.

Temperature Compensation Dielectric

Size (EIA Code)	CM02 (01005)	CM03 (0201)			CM05 (0402)			CM105 (0603)		CM21 (0805)					
Temperature	CΔ*1	CΔ*1		UΔ*2		SL	CΔ*1	UΔ*2	SL	CΔ*1		CΔ*1			
Rated Voltage (VDC)	16	25	50	16	25	25	50	50	50	50	100	16	25	50	100
Capacitance (pF)															
R20 0.2															
R50 0.5															
1R0 1.0															
1R5 1.5															
2.0															
3.0															
4.0															
5.0															
6.0															
7.0															
8.0															
9.0															
100 10															
120 12															
15 15															
18 18															
22 22															
27 27															
33 33															
39 39															
47 47															
56 56															
68 68															
82 82															
101 100															
121 120															
150 150															
180 180															
220 220															
270 270															
330 330															
390 390															
470 470															
560 560															
680 680															
820 820															
102 1000															
122 1200															
1500 1500															
1800 1800															
2200 2200															
2700 2700															
3300 3300															
3900 3900															
4700 4700															
5600 5600															
6800 6800															
8200 8200															
103 10000															
123 12000															
15000 15000															
18000 18000															

* E24 series is available on request.

Optional Spec.

*1: CG,CH,CJ,CK

*2: UJ,UK

Alphabets in capacitance chart denote dimensions. Please refer to the below table for detail.

(Example)
 In case of "B" for CM03;
 L : 0.6±0.03mm
 W : 0.3±0.03mm
 T : 0.3±0.03mm

Size	Size Code	Dimension (mm)		
		L	W	T
02	A	0.4±0.02	0.2±0.02	0.2±0.02
03	B	0.6±0.03	0.3±0.03	0.3±0.03
05	C	1.0±0.05	0.5±0.05	0.5±0.05
105	B	1.6±0.10	0.8±0.10	0.8±0.10
21	D	2.0±0.10	1.25±0.10	0.6±0.10
	E			0.85±0.10
	G			1.25±0.10

X5R Dielectric

Size (EIA Code)	CM02 (01005)		CM03 (0201)				CM05 (0402)					CM105 (0603)					CM21 (0805)						
	Rated Voltage (VDC)	Capacitance (pF)	6.3	10	16	25	4	6.3	10	16	25	50	6.3	10	16	25	50	4	6.3	10	16	25	50
101	100																						
151	150																						
	220																						
	330																						
	470																						
102	680																						
	1000																						
	1500																						
	2200																						
152	3300																						
	4700																						
	6800																						
	10000																						
103	15000																						
	22000																						
	33000																						
	47000																						
153	68000																						
	100000																						
	150000																						
	220000																						
104	330000																						
	470000																						
	680000																						
	1000000																						
105	2200000																						
	4700000																						
	10000000																						
	22000000																						
106	47000000																						
	100000000																						
	220000000																						
	470000000																						
107	1000000000																						

Size (EIA Code)	CM316 (1206)					CM32 (1210)					CM43 (1812)			
	Rated Voltage (VDC)	Capacitance (pF)	6.3	10	16	25	50	4	6.3	10	16	25	50	6.3
105	220000													
	470000													
	1000000													
	2200000													
106	4700000													
	10000000													
	22000000													
	47000000													
107	100000000													

- E6 series is standard.
- E3 series is standard for the size 316 and larger.
- E12 series is available on request.
- ▨ Optional Spec.

Two digits alphanumeric in capacitance chart denote dimensions and tan δ. Please refer to the below table for detail.

(Example)
In case of "B2" for CM03:
L : 0.6±0.03mm
W : 0.3±0.03mm
T : 0.3±0.03mm
Tan δ : 3.5% max.

Size	Size Code	Dimension (mm)		
		L	W	T
02	A	0.4±0.02	0.2±0.02	0.2±0.02
	B	0.6±0.03	0.3±0.03	0.3±0.03
03	C	0.6±0.05	0.3±0.05	0.3±0.05
	D	1.0±0.05	0.5±0.05	0.5±0.05
05	E	1.0±0.10	0.5±0.10	0.5±0.10
	F	1.0±0.15	0.5±0.15	0.5±0.15
	G	1.6±0.10	0.8±0.10	0.8±0.10
105	H	1.6±0.15	0.8±0.15	0.8±0.15
	I	2.0±0.10	1.25±0.10	0.6±0.10
21	J	2.0±0.10	1.25±0.10	0.85±0.10
	K	2.0±0.10	1.25±0.10	1.25±0.10
	L	2.0±0.15	1.25±0.15	1.25±0.15
	M	2.0±0.20	1.25±0.20	1.25±0.20

Size	Size Code	Dimension (mm)		
		L	W	T
316	D	3.2±0.20	1.6±0.15	1.15±0.10
	F	3.2±0.20	1.6±0.15	1.6±0.15
	J	3.2±0.20	1.6±0.20	1.6±0.20
	K	3.2±0.20	1.6±0.20	1.6±0.20
32	B	3.2±0.20	2.5±0.20	1.40 max.
	C	3.2±0.20	2.5±0.20	1.60 max.
	F	3.2±0.20	2.5±0.20	2.0±0.2
	G	3.2±0.20	2.5±0.20	2.5±0.2
43	D	4.5±0.30	3.2±0.20	2.5±0.2
	F	4.5±0.30	3.2±0.20	2.8±0.2

Tan δ Code	Tan δ
1	2.5% max.
2	3.5% max.
3	5.0% max.
4	7.0% max.
5	7.5% max.
7	10.0% max.
8	12.5% max.
9	20.0% max.

X7R Dielectric

Size (EIA Code)	CM02 (01005)	CM03 (0201)			CM05 (0402)			CM105 (0603)						CM21 (0805)						
Rated Voltage (VDC)	10	10	16	25	16	25	50	6.3	10	16	25	50	100	6.3	10	16	25	50	100	
Capacitance (pF)																				
101 100																				
151 150 220 330	A8		B2	B2																
102 470 680 1000							C1													
152 1500 2200 3300		B3																		
103 4700 6800 10000																				D1 E1
153 15000 22000 33000																				D1 E1 G1
104 47000 68000 100000						C8	C8													
105 220000 470000 1000000									B3 B8	B2 B8	B2 D8									G3 G8 G8 G8
106 2200000 4700000 10000000 22000000																				

Size (EIA Code)	CM316 (1206)						CM32 (1210)					CM43 (1812)	
Rated Voltage (VDC)	6.3	10	16	25	50	100	10	16	25	50	100	50	100
Capacitance (pF)													
104 47000 100000					A1 D1	D1 F1						B1 F1 G1	
105 220000 470000 1000000			D2	D2 F2					B2 F2	B1 F1		B1 D1	D1
106 2200000 4700000 10000000 22000000	J8	F3 J8	J8	J8			G8	G2 G8					

Optional Spec.

Two digits alphanumeric in capacitance chart denote dimensions and tan δ. Please refer to the below table for detail.

(Example)
In case of "B3" for CM03;
L : 0.6±0.03mm
W : 0.3±0.03mm
T : 0.3±0.03mm
Tan δ : 5.0% max.

Size	Size Code	Dimension (mm)		
		L	W	T
02	A	0.4±0.02	0.2±0.02	0.2±0.02
03	B	0.6±0.03	0.3±0.03	0.3±0.03
05	C	1.0±0.05	0.5±0.05	0.5±0.05
105	B	1.6±0.10	0.8±0.10	0.8±0.10
	D	1.6±0.15	0.8±0.15	0.8±0.15
21	D			0.6±0.10
	E	2.0±0.10	1.25±0.10	0.85±0.10
	G			1.25±0.10
	M	2.0±0.20	1.25±0.20	1.25±0.20
316	A			0.85±0.10
	D	3.2±0.20	1.6±0.15	1.15±0.10
	F			1.6±0.15
	J	3.2±0.20	1.6±0.20	1.6±0.20
32	B			1.40 max.
	F	3.2±0.20	2.5±0.20	2.0±0.2
	G			2.5±0.2
43	B			2.0±0.2
	D	4.5±0.30	3.2±0.20	2.5±0.2

Tan δ Code	Tan δ
1	2.5% max.
2	3.5% max.
3	5.0% max.
8	12.5% max.

Y5V Dielectric

Size (EIA Code)	CM03 (0201)		CM05 (0402)				CM105 (0603)				CM21 (0805)				CM316 (1206)			CM32 (1210)			
	6.3	10	10	16	25	50	10	16	25	50	10	16	25	50	10	16	25	10	16	25	
Rated Voltage (VDC) Capacitance (pF)																					
102 1000 2200 472 4700		B8																			
103 10000 22000 473 47000	B8			C6	C3	C3				B3	B3										
104 100000 220000 474 470000			C8					B6	B3 B4			E6	D3 E3 G3	E3 G3							
105 1000000 2200000 475 4700000							B8					G8	G6	G4		D6	D4				
106 10000000 22000000 476 47000000															F8 F9	F6		F8	C6	C6	

Two digits alphanumeric in capacitance chart denote dimensions and tan δ.
Please refer to the below table for detail.

(Example)
In case of "B8" for CM03;
L : 0.6±0.03mm
W : 0.3±0.03mm
T : 0.3±0.03mm
Tan δ : 12.5% max.

Size	Size Code	Dimension (mm)		
		L	W	T
03	B	0.6±0.03	0.3±0.03	0.3±0.03
05	C	1.0±0.05	0.5±0.05	0.5±0.05
105	B	1.6±0.10	0.8±0.10	0.8±0.10
21	D	2.0±0.10	1.25±0.10	0.6±0.10
	E	2.0±0.10	1.25±0.10	0.85±0.10
	G	2.0±0.10	1.25±0.10	1.25±0.10
316	D	3.2±0.20	1.6±0.15	1.15±0.10
	F	3.2±0.20	1.6±0.15	1.6±0.15
32	C	3.2±0.20	2.5±0.20	1.60 max.
	F	3.2±0.20	2.5±0.20	2.0±0.2

Tan δ Code	Tan δ
3	5.0% max.
4	7.0% max.
6	9.0% max.
8	12.5% max.
9	16.0% max.

Test Conditions and Specifications for Temperature Compensation Type (CΔ to UΔ • SL Characteristics) CM/ CT/ CF/ CA Series

Test Items		Specifications	Test Conditions									
Capacitance Value (C)		Within tolerance										
Q		C≥30pF : Q≥1000 C<30pF : Q≥400+20C	<table border="1"> <thead> <tr> <th>Capacitance</th> <th>Frequency</th> <th>Volt</th> </tr> </thead> <tbody> <tr> <td>C≤1000pF</td> <td>1MHz±10%</td> <td rowspan="2">0.5 to 5Vrms</td> </tr> <tr> <td>C>1000pF</td> <td>1kHz±10%</td> </tr> </tbody> </table>	Capacitance	Frequency	Volt	C≤1000pF	1MHz±10%	0.5 to 5Vrms	C>1000pF	1kHz±10%	
Capacitance	Frequency	Volt										
C≤1000pF	1MHz±10%	0.5 to 5Vrms										
C>1000pF	1kHz±10%											
Insulation Resistance (IR)		Over 10000MΩ or 500MΩ • μF, whichever is less	Measured after the rated voltage is applied for 1 minute at room ambient. For the rated voltage of over 630V, apply 500V for 1 minute at room ambient. The charge and discharge current of the capacitor must not exceed 50mA.									
Dielectric Resistance		No problem observed	Apply 3 times of the rated voltage for 1 to 5 seconds. Apply 1.5 times when the rated voltage is 250V or over. Apply 1.2 times when the rated voltage is 630V or over. The charge and discharge current of the capacitor must not exceed 50mA.									
Appearance		No problem observed	Microscope (10× magnification)									
Termination Strength		No problem observed	Apply a sideward force of 500g (5N) to a PCB-mounted sample. Apply 2N for 0201, and 1N for 01005 size.									
Bending Strength		No significant damage at 1mm bent	Glass epoxy PCB: Fulcrum spacing: 90mm, duration time 10 seconds.									
Vibration Test	Appearance	No problem observed	Vibration frequency: 10 to 55 (Hz) Amplitude: 1.5mm Sweeping condition: 10→55→10Hz/ 1 minute in X, Y and Z Directions: 2 hours each, 6 hours total.									
	ΔC	Within Tolerance										
	Q	C≥30pF : Q≥1000 C<30pF : Q≥400+20C										
Soldering Heat Resistance	Appearance	No problem observed	Soak the sample in 260°C±5°C solder for 10±0.5 seconds and place in room ambient, and measure after 24±2 hours. (Pre-heating conditions)									
	ΔC	Within ±2.5% or ±0.25pF, whichever is larger										
	Q	C≥30pF : Q≥1000 C<30pF : Q≥400+20C										
	IR	Over 10000MΩ or 500MΩ • μF whichever is less										
	Withstanding Voltage	Resist without problem										
Solderability		Solder coverage : 90% min.	Soaking condition <table border="1"> <thead> <tr> <th>Order</th> <th>Temperature</th> <th>Time</th> </tr> </thead> <tbody> <tr> <td>1</td> <td>80 to 100°C</td> <td>2 minutes</td> </tr> <tr> <td>2</td> <td>150 to 200°C</td> <td>2 minutes</td> </tr> </tbody> </table> <p>The charge and discharge current of the capacitor must not exceed 50mA for IR and withstanding voltage measurement.</p>	Order	Temperature	Time	1	80 to 100°C	2 minutes	2	150 to 200°C	2 minutes
Order	Temperature	Time										
1	80 to 100°C	2 minutes										
2	150 to 200°C	2 minutes										
Temperature Cycle	Appearance	No problem observed	(Cycle) Room temperature (3min.)→ Lowest operation temperature (30min.)→ Room temperature (3min.)→ Highest operation temperature(30min.) After 5 cycles, measure after 24±2 hours. The charge and discharge current of the capacitor must not exceed 50mA for IR and withstanding voltage measurement.									
	ΔC	Within ±2.5% or ±0.25pF, whichever is larger										
	Q	C≥30pF : Q≥1000 C<30pF : Q≥400+20C										
	IR	Over 10000MΩ or 500MΩ • μF, whichever is less										
	Withstanding Voltage	Resist without problem										
Load Humidity Test (Except CF Series)	Appearance	No problem observed	After applying rated voltage for 500+12/-0 hours in pre-condition at 40°C±2°C, humidity 90 to 95%RH, allow parts to stabilize for 24±2 hours, at room temperature before measurement. The charge and discharge current of the capacitor must not exceed 50mA for IR measurement.									
	ΔC	Within ±7.5% or ±0.75pF, whichever is larger										
	Q	C≥30pF : Q≥200 C<30pF : Q≥100+10C/ 3										
	IR	Over 500MΩ or 25MΩ • μF, whichever is less										
High-Temperature with Loading	Appearance	No problem observed.	After applying twice the rated voltage at the temperature of 125±3°C for 1000+12/-0 hours, measure the sample after 24±2 hours. Apply 1.5 times when the rated voltage is 250V or over. Apply 1.2 times when the rated voltage is 630V or over. The charge and discharge current of the capacitor must not exceed 50mA for IR measurement.									
	ΔC	Within ±3% or ±0.3pF, whichever is larger										
	Q	C≥30pF : Q≥350 10pF<C<30pF : Q≥275+5C/ 2 C<10pF : Q≥200+10C										
	IR	Over 1000MΩ or 50MΩ • μF, whichever is less										

Test Conditions and Specifications for High Dielectric Type (X5R, X7R) CM/ CT/ CA Series

Test Items		Specifications	Test Conditions									
Capacitance Value (C)		Within tolerance	Measure after heat treatment									
Tanδ (%)		Refer to capacitance chart	<table border="1"> <thead> <tr> <th>Capacitance</th> <th>Frequency</th> <th>Volt</th> </tr> </thead> <tbody> <tr> <td>C≤10μF</td> <td>1kHz±10%</td> <td>1.0±0.2Vrms</td> </tr> <tr> <td>C>10μF</td> <td>120Hz±10%</td> <td>0.5±0.2Vrms</td> </tr> </tbody> </table>	Capacitance	Frequency	Volt	C≤10μF	1kHz±10%	1.0±0.2Vrms	C>10μF	120Hz±10%	0.5±0.2Vrms
Capacitance	Frequency	Volt										
C≤10μF	1kHz±10%	1.0±0.2Vrms										
C>10μF	120Hz±10%	0.5±0.2Vrms										
Insulation Resistance (IR)		Over 10000MΩ or 500MΩ • μF, whichever is less	Measured after the rated voltage is applied for 1 minute at room ambient. The charge and discharge current of the capacitor must not exceed 50mA.									
Dielectric Resistance		No problem observed	Apply 2.5 times of the rated voltage for 1 to 5 seconds. The charge and discharge current of the capacitor must not exceed 50mA.									
Appearance		No problem observed	Microscope (10× magnification)									
Termination Strength		No problem observed	Apply a sideward force of 500g (5N) to a PCB-mounted sample. note : 2N for 0201 size in for 01005 size. Exclude CT series with thickness of less than 0.66mm.									
Bending Strength		No significant damage at 1mm bent	Glass epoxy PCB: Fulcrum spacing: 90mm, duration time 10 seconds. Exclude CT series with thickness of less than 0.66mm.									
Vibration Test	Appearance	No problem observed	Take the initial value after heat treatment. Vibration frequency: 10 to 55 (Hz) Amplitude: 1.5mm Sweeping condition: 10→55→10Hz/ 1 minute in X, Y and Z Directions: 2 hours each, 6 hours total.									
	ΔC	Within tolerance										
	Tanδ (%)	Within tolerance										
Soldering Heat Resistance	Appearance	No problem observed	Take the initial value after heat treatment. Soak the sample in 260°C±5°C solder for 10±0.5 seconds and place in room ambient, and measure after 24±2 hours. (Pre-heating conditions)									
	ΔC	Within ±7.5%										
	Tanδ (%)	Within tolerance										
	IR	Over 10000MΩ or 500MΩ • μF, whichever is less										
	Withstanding Voltage	Resist without problem										
Solderability		Solder coverage : 90% min.	Soaking condition <table border="1"> <thead> <tr> <th>Order</th> <th>Temperature</th> <th>Time</th> </tr> </thead> <tbody> <tr> <td>1</td> <td>80 to 100°C</td> <td>2 minutes</td> </tr> <tr> <td>2</td> <td>150 to 200°C</td> <td>2 minutes</td> </tr> </tbody> </table>	Order	Temperature	Time	1	80 to 100°C	2 minutes	2	150 to 200°C	2 minutes
Order	Temperature	Time										
1	80 to 100°C	2 minutes										
2	150 to 200°C	2 minutes										
Temperature Cycle	Appearance	No problem observed	Take the initial value after heat treatment. (Cycle) Room temperature (3min.)→ Lowest operation temperature (30min.)→ Room temperature (3min.)→ Highest operation temperature(30min.) After 5 cycles, measure after 24±2 hours. The charge and discharge current of the capacitor must not exceed 50mA for IR and withstanding voltage measurement.									
	ΔC	Within ±7.5%										
	Tanδ (%)	Within tolerance										
	IR	Over 10000MΩ or 500MΩ • μF, whichever is less										
	Withstanding Voltage	Resist without problem										
Load Humidity Test	Appearance	No problem observed	Take the initial value after voltage treatment. After applying rated voltage for 500+12/ -0 hours in pre-condition at 40°C±2°C, humidity 90 to 95%RH, allow parts to stabilize for 24±2 hours, at room temperature before measurement. The charge and discharge current of the capacitor must not exceed 50mA for IR measurement.									
	ΔC	Within ±12.5%										
	Tanδ (%)	200% max. of initial value										
	IR	Over 500MΩ or 25MΩ • μF, whichever is less										
High-Temperature with Loading	Appearance	No problem observed	Take the initial value after voltage treatment. After applying twice the rated voltage at the highest operation temperature for 1000+12/ -0 hours, measure the sample after 24±2 hours. The charge and discharge current of the capacitor must not exceed 50mA for IR measurement. Apply 1.5 times when the rated voltage is 10V or less. Applied voltages for respective products are indicated in the below chart.									
	ΔC	Within ±12.5%										
	Tanδ (%)	200% max. of initial value										
	IR	Over 1000MΩ or 50MΩ • μF, whichever is less										
Pre-treatment	Heat	Keep specimen at 150+0/ -10°C for 1 hour, leave specimen at room ambient for 24±2 hours.										
	Voltage	Apply the same test condition for 1 hour, then leave the specimen at room ambient for 24±2 hours.										

High-temperature with Loading Applied Voltage (Rated Voltage × □)

Applied Voltage	Rated Voltage	Products
×1.3	6.3V	CM105X5R475, CM316X5R476 CT05X5R104, CT21X5R106
		CM105X7R474-105, CM21X7R105-475, CM316X7R475-106, CM32X7R106-226, CM05X5R224, CM105X5R225, CM21X5R475-106, CM316X5R226 CT105X5R105, CT21X5R225-475, CT316X5R106
×1.5	16V	CM105X7R474, CM21X7R105-225, CM316X7R475, CM32X7R106, CM105X5R474-105, CM21X5R225-106, CM316X5R106, CM32X5R106-226 CT316X5R225-106
	25V	CM21X5R105
	50V	CT21X5R225, CT316X5R225-475

Multilayer Ceramic Chip Capacitors

Test Conditions and Standards



Test Conditions and Specifications for High Dielectric Type (Y5V) CM/ CT/ CA Series

Test Items		Specifications	Test Conditions									
Capacitance Value (C)		Within tolerance	Measure after heat treatment									
Tanδ (%)		Refer to capacitance chart	<table border="1"> <thead> <tr> <th>Frequency</th> <th>Volt</th> </tr> </thead> <tbody> <tr> <td>1kHz\pm10%</td> <td>1.0\pm0.2Vrms</td> </tr> </tbody> </table>	Frequency	Volt	1kHz \pm 10%	1.0 \pm 0.2Vrms					
Frequency	Volt											
1kHz \pm 10%	1.0 \pm 0.2Vrms											
Insulation Resistance (IR)		Over 10000M Ω or 500M Ω \cdot μ F, whichever is less	Measured after the rated voltage is applied for 1 minute at room ambient.									
Dielectric Resistance		No problem observed	Apply 2.5 times of the rated voltage for 1 to 5 seconds. The charge and discharge current of the capacitor must not exceed 50mA.									
Appearance		No problem observed	Microscope (10 \times magnification)									
Termination Strength		No problem observed	Apply a sideward force of 500g (5N) to a PCB-mounted sample. note : 2N for 0201 size in for 01005 size. Exclude CT series with thickness of less than 0.66mm.									
Bending Strength		No significant damage at 1mm bent	Glass epoxy PCB: Fulcrum spacing: 90mm, duration time 10 seconds. Exclude CT series with thickness of less than 0.66mm.									
Vibration Test	Appearance	No problem observed	Take the initial value after heat treatment. Vibration frequency: 10 to 55 (Hz) Amplitude: 1.5mm Sweeping condition: 10 \rightarrow 55 \rightarrow 10Hz/ 1 minute in X, Y and Z Directions: 2 hours each, 6 hours total.									
	ΔC	Within tolerance										
	Tanδ (%)	Within tolerance										
Soldering Heat Resistance	Appearance	No problem observed	Take the initial value after heat treatment. Soak the sample in 260 $^{\circ}$ C \pm 5 $^{\circ}$ C solder for 10 \pm 0.5 seconds and place in room ambient, and measure after 24 \pm 2 hours. (Pre-heating conditions) <table border="1"> <thead> <tr> <th>Order</th> <th>Temperature</th> <th>Time</th> </tr> </thead> <tbody> <tr> <td>1</td> <td>80 to 100$^{\circ}$C</td> <td>2 minutes</td> </tr> <tr> <td>2</td> <td>150 to 200$^{\circ}$C</td> <td>2 minutes</td> </tr> </tbody> </table> The charge and discharge current of the capacitor must not exceed 50mA for IR and withstanding voltage measurement.	Order	Temperature	Time	1	80 to 100 $^{\circ}$ C	2 minutes	2	150 to 200 $^{\circ}$ C	2 minutes
	Order	Temperature		Time								
	1	80 to 100 $^{\circ}$ C		2 minutes								
	2	150 to 200 $^{\circ}$ C		2 minutes								
	ΔC	Within \pm 20%										
Tanδ (%)	Within tolerance											
IR	Over 10000M Ω or 500M Ω \cdot μ F, whichever is less											
Withstanding Voltage	Resist without problem											
Solderability		Solder coverage : 90% min.	Soaking condition <table border="1"> <tbody> <tr> <td>Sn63 Solder</td> <td>235\pm5$^{\circ}$C</td> <td>2\pm0.5 sec.</td> </tr> <tr> <td>Sn-3Ag-0.5Cu</td> <td>245\pm5$^{\circ}$C</td> <td>3\pm0.5 sec.</td> </tr> </tbody> </table>	Sn63 Solder	235 \pm 5 $^{\circ}$ C	2 \pm 0.5 sec.	Sn-3Ag-0.5Cu	245 \pm 5 $^{\circ}$ C	3 \pm 0.5 sec.			
Sn63 Solder	235 \pm 5 $^{\circ}$ C	2 \pm 0.5 sec.										
Sn-3Ag-0.5Cu	245 \pm 5 $^{\circ}$ C	3 \pm 0.5 sec.										
Temperature Cycle	Appearance	No problem observed	Take the initial value after heat treatment. (Cycle) Room temperature (3min.) \rightarrow Lowest operation temperature (30min.) \rightarrow Room temperature (3min.) \rightarrow Highest operation temperature(30min.) After 5 cycles, measure after 24 \pm 2 hours. The charge and discharge current of the capacitor must not exceed 50mA for IR and withstanding voltage measurement.									
	ΔC	Within \pm 20%										
	Tanδ (%)	Within tolerance										
	IR	Over 10000M Ω or 500M Ω \cdot μ F, whichever is less										
	Withstanding Voltage	Resist without problem										
Load Humidity Test	Appearance	No problem observed	Take the initial value after voltage treatment. After applying rated voltage for 500+12/ -0 hours in pre-condition at 40 $^{\circ}$ C \pm 2 $^{\circ}$ C, humidity 90 to 95%RH, allow parts to stabilize for 24 \pm 2 hours, at room temperature before measurement. The charge and discharge current of the capacitor must not exceed 50mA for IR measurement.									
	ΔC	Within \pm 30%										
	Tanδ (%)	150% max. of initial value										
	IR	Over 500M Ω or 25M Ω \cdot μ F, whichever is less										
High-Temperature with Loading	Appearance	No problem observed	Take the initial value after voltage treatment. After applying twice the rated voltage at the highest operation temperature for 1000+12/ -0 hours, measure the sample after 24 \pm 2 hours. The charge and discharge current of the capacitor must not exceed 50mA for IR measurement.									
	ΔC	Within \pm 30%										
	Tanδ (%)	150% max. of initial value										
	IR	Over 1000M Ω or 50M Ω \cdot μ F, whichever is less										
Pre-treatment	Heat	Keep specimen at 150+0/ -10 $^{\circ}$ C for 1 hour, leave specimen at room ambient for 24 \pm 2 hours.										
	Voltage	Apply the same test condition for 1 hour, then leave the specimen at room ambient for 24 \pm 2 hours.										

Test Conditions and Specifications for High Dielectric Type (X7R) CF Series

Test Items		Specifications	Test Conditions									
Capacitance Value (C)		Within tolerance	Measure after heat treatment									
Tanδ (%)		Within ±2.5%	<table border="1"> <thead> <tr> <th>Capacitance</th> <th>Frequency</th> <th>Volt</th> </tr> </thead> <tbody> <tr> <td>C≤10μF</td> <td>1kHz±10%</td> <td>1.0±0.2Vrms</td> </tr> </tbody> </table>	Capacitance	Frequency	Volt	C≤10μF	1kHz±10%	1.0±0.2Vrms			
Capacitance	Frequency	Volt										
C≤10μF	1kHz±10%	1.0±0.2Vrms										
Insulation Resistance (IR)		Over 10000MΩ or 500MΩ • μF, whichever is less Over 100MΩ • μF for CF316X7R104/ 250V and CF43X7R474/ 250V CF55X7R105/ 250V and CF55X7R224/ 630V	Measured after the rated voltage is applied for 1 minute at room ambient. Measured after the 500V is applied for 1 minute at room ambient for the rated voltage over 630V. The charge and discharge current of the capacitor must not exceed 50mA.									
Dielectric Resistance		No problem observed	Apply 1.5 times when the rated voltage is 250V or over, apply 1.2 times when the rated voltage is 630V or over for 1 to 5 seconds. The charge and discharge current of the capacitor must not exceed 50mA.									
Appearance		No problem observed	Microscope (10× magnification)									
Termination Strength		No problem observed	Apply a sideward force of 500g (5N) to a PCB-mounted sample.									
Bending Strength		No significant damage at 1mm bent	Glass epoxy PCB: Fulcrum spacing: 90mm, duration time 10 seconds.									
Vibration Test	Appearance	No problem observed	Take the initial value after heat treatment. Vibration frequency: 10 to 55 (Hz) Amplitude: 1.5mm Sweeping condition: 10→55→10Hz/ 1 minute in X, Y and Z Directions: 2 hours each, 6 hours total.									
	ΔC	Within tolerance										
	Tanδ (%)	Within tolerance										
Soldering Heat Resistance	Appearance	No problem observed	Take the initial value after heat treatment. Soak the sample in 260°C±5°C solder for 10±0.5 seconds and place in room ambient, and measure after 24±2 hours. (Pre-heating conditions)									
	ΔC	Within ±7.5%										
	Tanδ (%)	Within tolerance										
	IR	Over 10000MΩ or 500MΩ • μF, whichever is less Over 100MΩ • μF for CF316X7R104/ 250V and CF43X7R474/ 250V CF55X7R105/ 250V and CF55X7R224/ 630V										
	Withstanding Voltage	Resist without problem										
Solderability		Solder coverage : 90% min.	Soaking condition <table border="1"> <thead> <tr> <th>Sn63 Solder</th> <th>Temperature</th> <th>Time</th> </tr> </thead> <tbody> <tr> <td>1</td> <td>80 to 100°C</td> <td>2 minutes</td> </tr> <tr> <td>2</td> <td>150 to 200°C</td> <td>2 minutes</td> </tr> </tbody> </table>	Sn63 Solder	Temperature	Time	1	80 to 100°C	2 minutes	2	150 to 200°C	2 minutes
Sn63 Solder	Temperature	Time										
1	80 to 100°C	2 minutes										
2	150 to 200°C	2 minutes										
Temperature Cycle	Appearance	No problem observed	Take the initial value after heat treatment. (Cycle) Room temperature (3min.)→ Lowest operation temperature (30min.)→ Room temperature (3min.)→ Highest operation temperature(30min.) After 5 cycles, measure after 24±2 hours. The charge and discharge current of the capacitor must not exceed 50mA for IR and withstanding voltage measurement.									
	ΔC	Within ±7.5%										
	Tanδ (%)	Within tolerance										
	IR	Over 10000MΩ or 500MΩ • μF, whichever is less Over 100MΩ • μF for CF316X7R104/ 250V and CF43X7R474/ 250V CF55X7R105/ 250V and CF55X7R224/ 630V										
	Withstanding Voltage	Resist without problem										
High-Temperature with Loading	Appearance	No problem observed	Take the initial value after voltage treatment. After applying specified voltage at the highest operation temperature for 1000+12/ -0 hours, then measure the sample after 24±2 hours. The applied voltage shall be; 1.5 times the rated voltage when the rated voltage is 250V or over. 1.2 times when the rated voltage is 630V or over. The charge and discharge current of the capacitor must not exceed 50mA for IR measurement.									
	ΔC	Within ±12.5%										
	Tanδ (%)	200% max. of initial value										
	IR	Over 1000MΩ or 50MΩ • μF, whichever is less										
Pre-treatment	Heat	Keep specimen at 150+0/ -10°C for 1 hour, leave specimen at room ambient for 24±2 hours.										
	Voltage	Apply the same test condition for 1 hour, then leave the specimen at room ambient for 24±2 hours.										

Substrate for Electrical Tests

(Unit: mm)

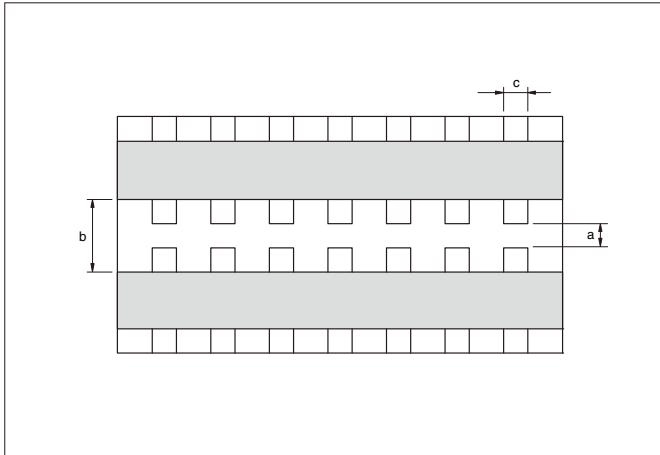

Size (EIA Code)	a	b	c
02 (01005)	0.15	0.50	0.20
03 (0201)	0.26	0.92	0.32
05 (0402)	0.4	1.4	0.5
105 (0603)	1.0	3.0	1.2
21 (0805)	1.2	4.0	1.65
316 (1206)	2.2	5.0	2.0
32 (1210)	2.2	5.0	2.9
42 (1808)	3.5	7.0	3.7
43 (1812)	3.5	7.0	3.7
52 (2208)	4.5	8.0	5.6
55 (2220)	4.5	8.0	5.6

Substrate for Bending Test

(Unit: mm)

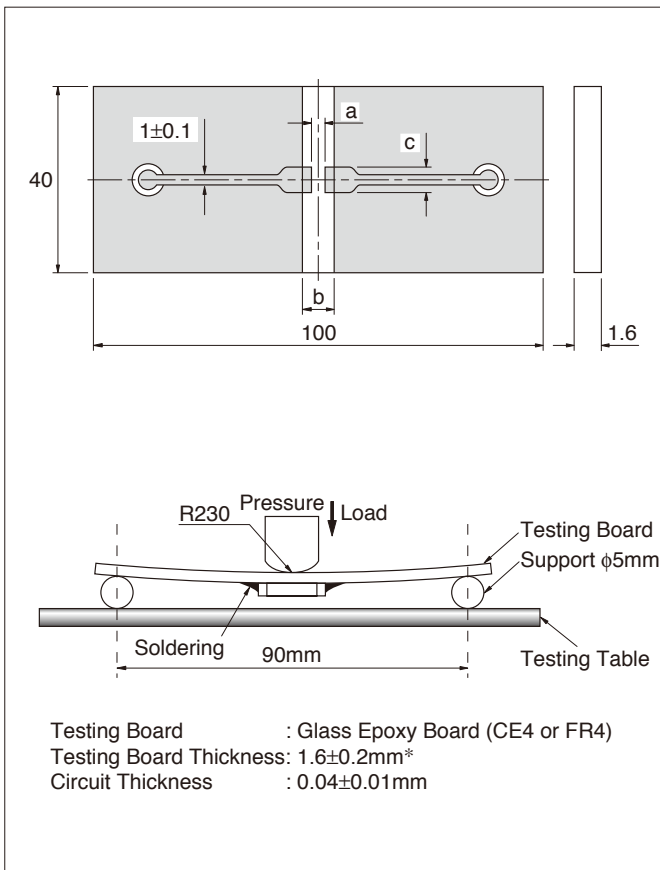

* 02, 03, 05 and array: $0.8 \pm 0.1\text{mm}$

Substrate for Adhesion Strength Test

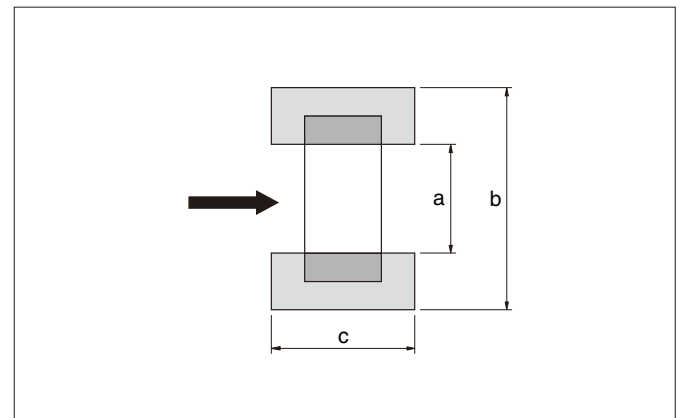

Tape and Reel

- Reel

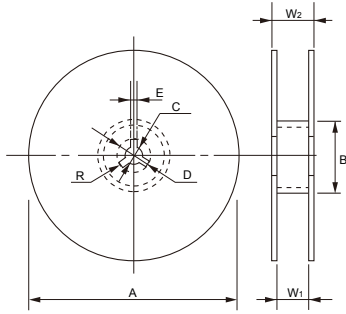

F=1mm (02, 03, 05 Type)

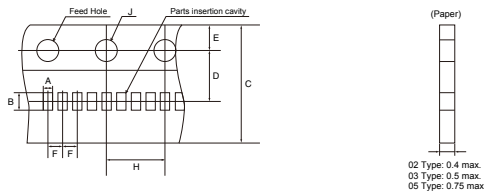

F=2mm (03, 05, 105 Type)

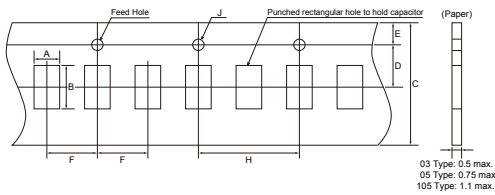

F=4mm (105, D11, F12, 21, 316, 32, 42, 52 Type)

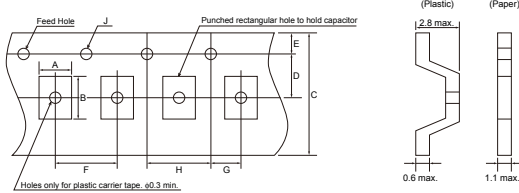

F=8mm (43, 55 Type)

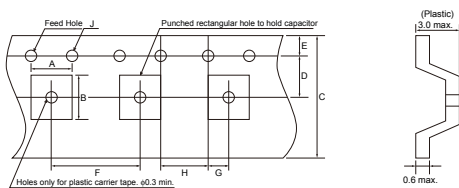

Reel

(Unit: mm)

Code Reel	A	B	C	D
7-inch Reel (CODE: T, H, Q)	180 ⁺⁰ _{-2.0}	φ60 min.	13±0.5	21±0.8
13-inch Reel (CODE: L, N)	330±2.0	φ100±1.0		
Code Reel	E	W ₁	W ₂	R
7-inch Reel (CODE: T, H, Q)	2.0±0.5	10.0±1.5	16.5 max.	1.0
13-inch Reel (CODE: L, N)		9.5±1.0		

* Carrier tape width 8mm.

For size 42 (1808) or over, Tape width 12mm and W₁: 14±1.5, W₂: 18.4mm max.

Carrier Tape

(Unit: mm)

Size (EIA Code)	A	B	F
02 (01005)	0.25±0.03	0.45±0.03	2.0±0.05
03 (0201)*	0.37±0.03	0.67±0.03	2.0±0.05
05 (0402)	0.65±0.1	1.15±0.1	2.0±0.05
105 (0603)	1.0±0.2	1.8±0.2	4.0±0.1
21 (0805)	1.5±0.2	2.3±0.2	4.0±0.1
316 (1206)	2.0±0.2	3.6±0.2	4.0±0.1
32 (1210)	2.9±0.2	3.6±0.2	4.0±0.1
42 (1808)	2.4±0.2	4.9±0.2	4.0±0.1
43 (1812)	3.6±0.2	4.9±0.2	8.0±0.1
52 (2208)	2.4±0.2	6.0±0.2	4.0±0.1
55 (2220)	5.3±0.2	6.0±0.2	8.0±0.1
D11 (0405)	1.15±0.2	1.55±0.2	4.0±0.1
F12 (0508)	1.5±0.2	2.3±0.2	4.0±0.1

* Option : A : 0.39±0.03, B : 0.69±0.03

(Unit: mm)

F	Carrier Tape	C	D	E	G	H	J
1.0 ±0.05	1mm Paper	8.0 +0.3/-0.1	3.5 ±0.05	1.75 ±0.1	2.0 ±0.05	4.0 ±0.05	1.5 ±0.1/-0
2.0 ±0.05	8mm Paper	8.0 ±0.3				4.0 ±0.1	
4.0 ±0.1	8mm Plastic	12.0 ±0.3	5.5 ±0.05	1.75 ±0.1	2.0 ±0.05	4.0 ±0.1	1.5 ±0.1/-0
8.0 ±0.1	12mm Plastic						

Detail of leader and trailer

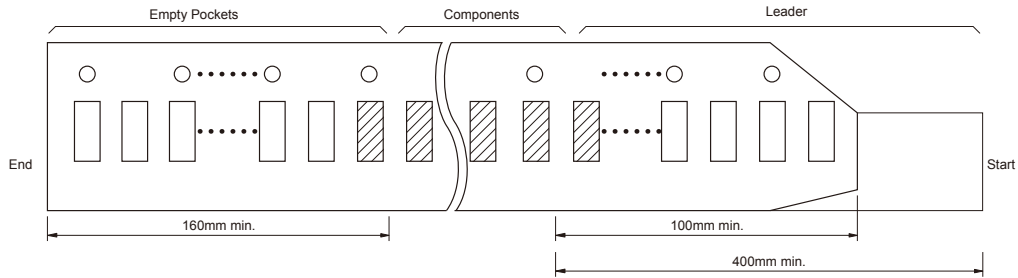

Adhesive tape

- 1) The exfoliative strength when peeling off the top tape from the carrier tape by the method of the following figure shall be 0.1-0.7N.
- 2) When the top tape is peeled off, the adhesive stays on the top tape.
- 3) Chip capacitors will be in a state free without being stuck on the thermal adhesive tape.

Exfoliating angle: 165 to 180 degrees to the carrier tape.
Exfoliating speed: 300 mm/min.

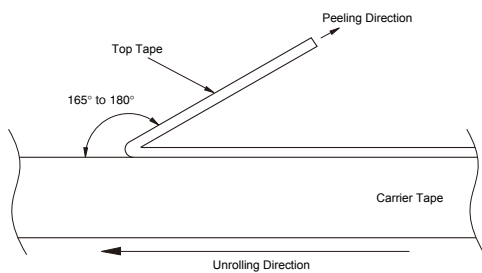

Bulk Case

(Unit: mm)

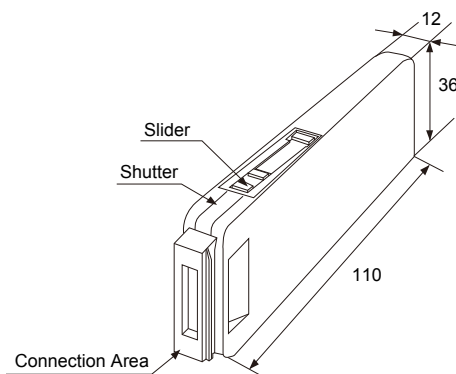

Package quantity

Size Code	Thickness (mm)	Package quantity (pcs.)
05	0.5	50,000
105	0.8	15,000
21	1.25	5,000

Note: Please check us for bulk case applicable products.

Bulk Case

Size Code	EIA CODE	JIS CODE	Dimensions (mm)						
			L	W	T	P min.	P max.	P to P min.	
05	0402	1005	1.0±0.05	0.5±0.05	0.5±0.05	0.15	0.35	0.30	
105	0603	1608	1.6±0.07	0.8±0.07	0.8±0.07	0.20	0.60	0.50	
21	0805	2012	2.0±0.1	1.25±0.1	1.25±0.1	0.20	0.75	0.70	

Note: Regarding support for Bulk cases, please contact us for further information.

Dimensions

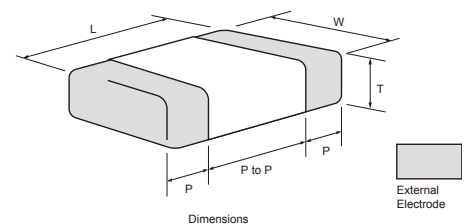

Dimensions for recommended typical land

Since the amount of solder (size of fillet) to be used has direct influence on the capacitor after mounting, the sufficient consideration is necessary.

When the amounts of solder is too much, the stress that a capacitor receives becomes larger. It may become the cause of a crack in the capacitor. When the land design of printed wiring board is considered, it is necessary to set up the form and size of land pattern so that the amount of solder is suitable.

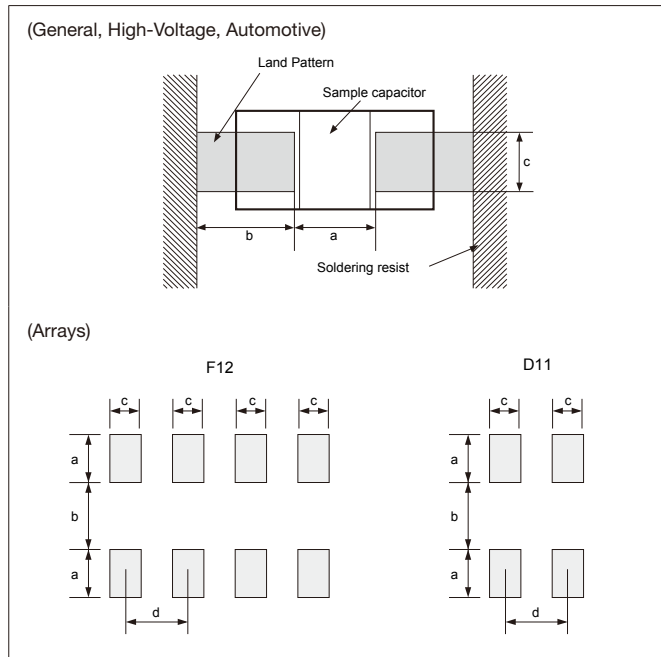

Design of printed circuit and Soldering

The recommended fillet height shall be 1/2 to 1/3 of the thickness of capacitors. When mounting two or more capacitors in the common land, it is necessary to separate the land with the solder resist strike so that it may become the exclusive land of each capacitor.

General, High-Voltage

(Unit: mm)

Size (EIA Code)	L×W	a	b	c
02 (01005)	0.4×0.2	0.13 to 0.20	0.12 to 0.18	0.20 to 0.23
03 (0201)	0.6×0.3	0.20 to 0.30	0.25 to 0.35	0.30 to 0.40
05 (0402)	1.0×0.5	0.30 to 0.50	0.35 to 0.45	0.40 to 0.60
105 (0603)	1.6×0.8	0.70 to 1.00	0.80 to 1.00	0.60 to 0.80
21 (0805)	2.0×1.25	1.00 to 1.30	1.00 to 1.20	0.80 to 1.10
316 (1206)	3.2×1.6	2.10 to 2.50	1.10 to 1.30	1.00 to 1.30
32 (1210)	3.2×2.5	2.10 to 2.50	1.10 to 1.30	1.90 to 2.30
42 (1808)	4.5×2.0	2.50 to 3.20	1.80 to 2.30	1.50 to 1.80
43 (1812)	4.5×3.2	2.50 to 3.20	1.80 to 2.30	2.60 to 3.00
52 (2208)	5.7×2.0	4.20 to 4.70	2.00 to 2.50	1.50 to 1.80
55 (2220)	5.7×5.0	4.20 to 4.70	2.00 to 2.50	4.20 to 4.70

Automotive

(Unit: mm)

Size (EIA Code)	L×W	a	b	c
105 (0603)	1.6×0.8	0.60 to 0.90	0.80 to 1.00	0.70 to 1.00
21 (0805)	2.0×1.25	0.90 to 1.20	0.80 to 1.20	0.90 to 1.40
316 (1206)	3.2×1.6	1.40 to 1.90	1.00 to 1.30	1.30 to 1.80

Arrays

(Unit: mm)

	a	b	c	d
F12 (0508)	0.5	0.5	0.3	0.5
D11 (0405)	0.69	0.28	0.3	0.64

Ideal Solder Height

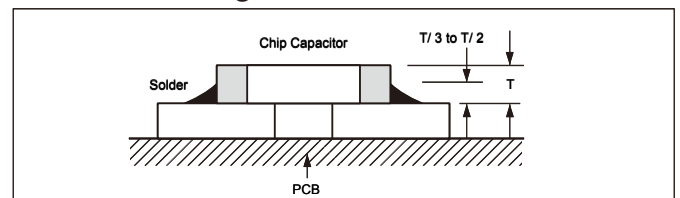

Item	Not recommended example	Recommended example/ Separated by solder
Multiple parts mount		
Mount with leaded parts		
Wire soldering after mounting		
Overview		

Mounting Design

The chip could crack if the PCB warps during processing after the chip has been soldered.

Recommended chip position on PCB to minimize stress from PCB warpage



Actual Mounting

- 1) If the position of the vacuum nozzle is too low, a large force may be applied to the chip capacitor during mounting, resulting in cracking.
- 2) During mounting, set the nozzle pressure to a static load of 100 to 300 gf.
- 3) To minimize the shock of the vacuum nozzle, provide a support pin on the back of the PCB to minimize PCB flexure.

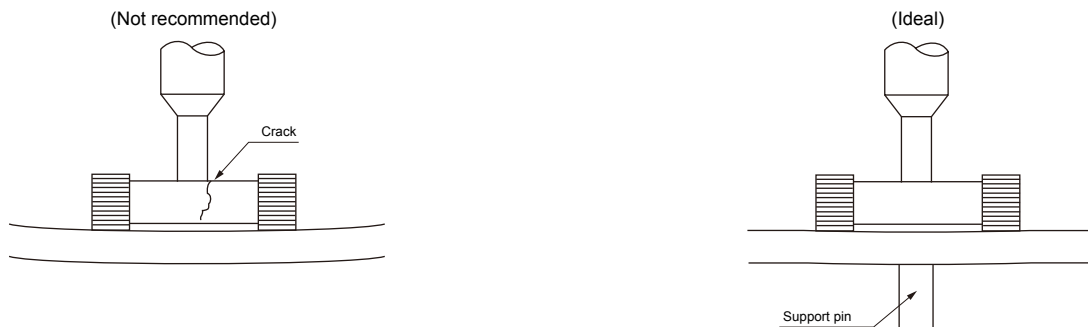

- 4) Bottom position of pick up nozzle should be adjusted to the top surface of a substrate which camber is corrected.
- 5) To reduce the possibility of chipping and cracks, minimize vibration to chips stored in a bulk case.
- 6) The discharge pressure must be adjusted to the part size. Verify the pressure during setup to avoid fracturing or cracking the chips capacitors.

Resin Mold

- 1) If a large amount of resin is used for molding the chip, cracks may occur due to contraction stress during curing. To avoid such cracks, use a low shrinkage resin.
- 2) The insulation resistance of the chip will degrade due to moisture absorption. Use a low moisture absorption resin.
- 3) Check carefully that the resin does not generate a decomposition gas or reaction gas during the curing process or during normal storage. Such gases may crack the chip capacitor or damage the device itself.

Soldering Method

- 1) Ceramic is easily damaged by rapid heating or cooling. If some heat shock is unavoidable, preheat enough to limit the temperature difference (Delta T) to within 130 degree Celsius.
- 2) The product size 1.0x0.5mm to 3.2x1.6mm can be used in reflow and wave soldering, and the product size of bigger than 3.2x1.6mm, or smaller than 1.0x0.5mm, and capacitor arrays can be used in reflow.
Circuit shortage and smoking can be created by using capacitors which are used neglecting the above caution.
- 3) Please see our recommended soldering conditions.
- 4) In case of using Sn-Zn Solder, please contact us in advance.
- 5) The following condition is recommended for spot heater application.

• Recommended spot heater condition

Item	Condition
Distance	5mm min.
Angle	45°
Projection Temp.	400°C max.
Flow rate	Set at the minimum
Nozzle diameter	2φ to 4φ (Single hole type)
Application time	10 sec. max. (1206 and smaller) 30 sec. max. (1210 and larger)

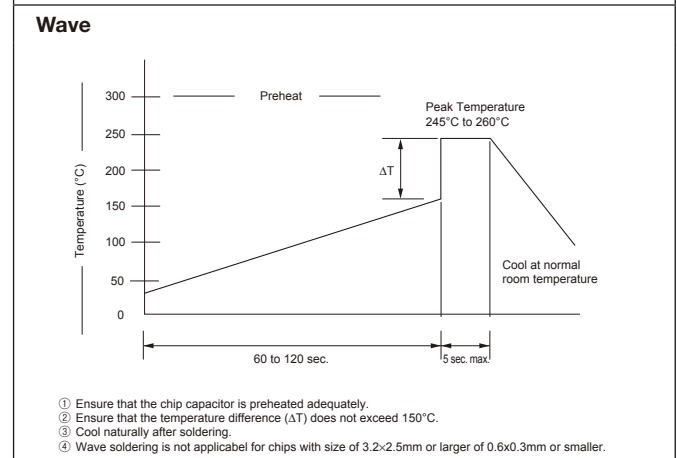
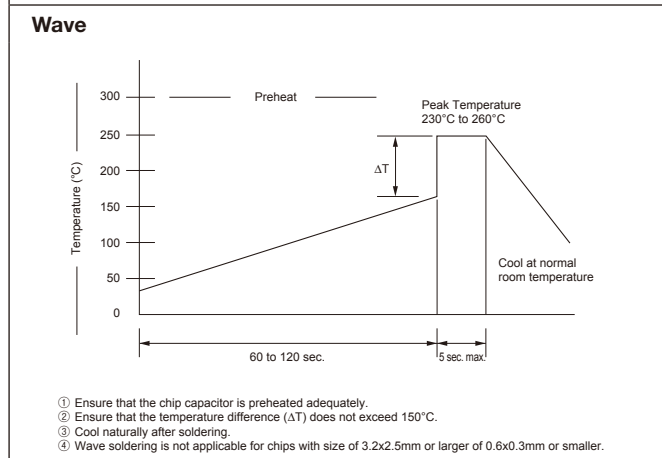
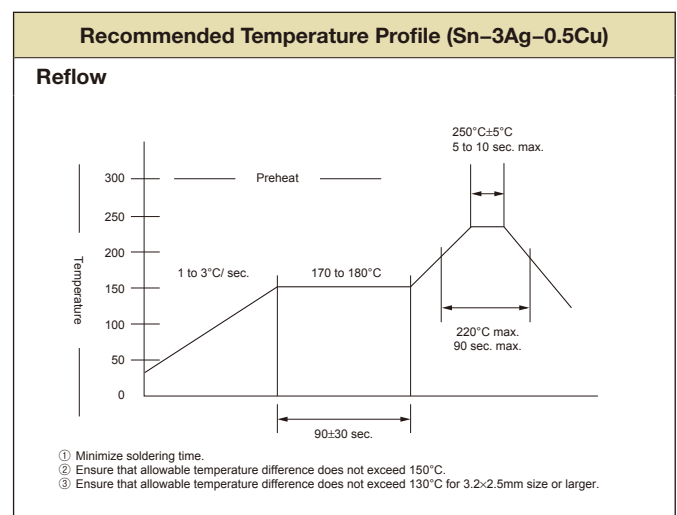
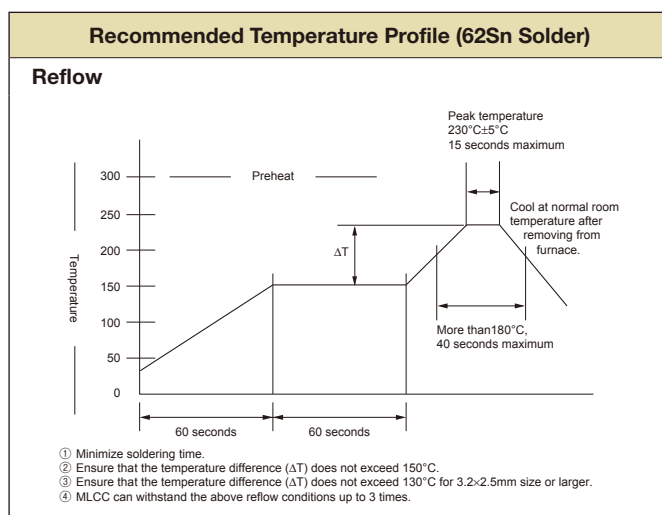
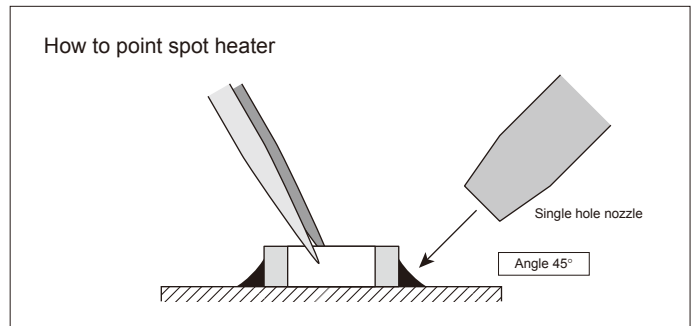

Soldering iron

- | | | |
|--------------------------------|---|---|
| 1) Temperature of iron chip | 1206 and smaller 350°C max.
1210 and larger 280°C max. | 5) Cautions |
| 2) Wattage | 80W max. | a) Pre-heating is necessary rapid heating must be avoided.
Delta T ≤ 150°C |
| 3) Tip shape of soldering iron | φ3.0mm max. | b) Avoid direct touching to capacitors. |
| 4) Soldering Time | 3 sec. max. | c) Avoid rapid cooling after soldering. Natural cooling is recommended. |
- *Consult as if it is difficult to keep the temperature 280°C max. for 1210 and larger MLCC'S.

Circuit Design

1. Once application and assembly environments have been checked, the capacitor may be used in conformance with the rating and performance which are provided in both the catalog and the specifications. Use exceeding that which is specified may result in inferior performance or cause a short, open, smoking, or flaming to occur, etc.
2. Please consult the manufacturer in advance when the capacitor is used in devices such as: devices which deal with human life, i.e. medical devices; devices which are highly public orientated; and devices which demand a high standard of liability.
Accident or malfunction of devices such as medical devices, space equipment and devices having to do with atomic power could generate grave consequence with respect to human lives or, possibly, a portion of the public. Capacitors used in these devices may require high reliability design different from that of general purpose capacitors.
3. Please use the capacitors in conformance with the operating temperature provided in both the catalog and the specifications.
Be especially cautious not to exceed the maximum temperature. In the situation the maximum temperature set forth in both the catalog and specifications is exceeded, the capacitor's insulation resistance may deteriorate, power may suddenly surge and short-circuit may occur. The capacitor has a loss, and may self-heat due to equivalent series resistance when alternating electric current is passed therethrough. As this effect becomes especially pronounced in high frequency circuits, please exercise caution.
When using the capacitor in a (self-heating) circuit, please make sure the surface of the capacitor remains under the maximum temperature for usage. Also, please make certain temperature rises remain below 20°C.
4. Please keep voltage under the rated voltage which is applied to the capacitor. Also, please make certain the peak voltage remains below the rated voltage when AC voltage is super-imposed to the DC voltage.
In the situation where AC or pulse voltage is employed, ensure average peak voltage does not exceed the rated voltage.
Exceeding the rated voltage provided in both catalog and specifications may lead to defective withstanding voltage or, in worst case situations, may cause the capacitor to smoke or flame.
5. When the capacitor is to be employed in a circuit in which there is continuous application of a high frequency voltage or a steep pulse voltage, even though it is within the rated voltage, please inquire to the manufacturer.
In the situation the capacitor is to be employed using a high frequency AC voltage or a extremely fast rising pulse voltage, even though it is within the rated voltage, it is possible capacitor reliability will deteriorate.
6. It is a common phenomenon of high-dielectric products to have a deteriorated amount of static electricity due to the application of DC voltage.
Due caution is necessary as the degree of deterioration varies depending on the quality of capacitor materials, capacity, as well as the load voltage at the time of operation.
7. Do not use the capacitor in an environment where it might easily exceed the respective provisions concerning shock and vibration specified in the catalog and specifications.
In addition, it is a common piezo phenomenon of high dielectric products to have some voltage due to vibration or to have noise due to voltage change. Please contact sales in such case.
8. If the electrostatic capacity value of the delivered capacitor is within the specified tolerance, please consider this when designing the respective product in order that the assembled product function appropriately.
9. Please contact us upon using conductive adhesives.

Storage

1. If the component is stored in minimal packaging (a heat-sealed or chuck-type plastic bag), the bag should be kept closed. Once the bag has been opened, reseal it or store it in a desiccator.
2. Keep storage place temperature +5 to +35 degree C, humidity 45 to 70% RH.
3. The storage atmosphere must be free of gas containing sulfur and chlorine. Also, avoid exposing the product to saline moisture. If the product is exposed to such atmospheres, the terminals will oxidize and solderability will be effected.
4. Precautions 1) to 3) apply to chip capacitors packaged in carrier tapes and bulk cases.
5. The solderability is assured for 12 months from our shipping date (six months for silver palladium) if the above storage precautions are followed.
6. Chip capacitors may crack if exposed to hydrogen (H₂) gas while sealed or if coated with silicon, which generates hydrogen gas.