

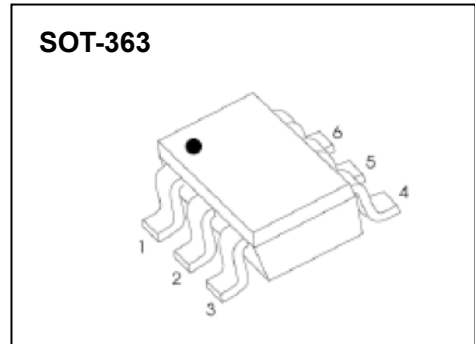

SOT-363 Plastic-Encapsulate MOSFETS

CJ3439KDW N channel+P Channel MOSFET

$V_{(BR)DSS}$	$R_{DS(on)MAX}$	I_D
20V	380mΩ@4.5V	0.75A
	450mΩ@2.5V	
	800mΩ@1.8V	
-20V	520mΩ@-4.5V	-0.66A
	700mΩ@-2.5V	
	950mΩ(TYP)@-1.8V	



FEATURE

- Surface Mount Package
- Low $R_{DS(on)}$
- Operated at Low Logic Level Gate Drive
- ESD Protected Gate
- Including a N-ch CJ3134K and a P-ch CJ3139K (independently) In a Package

APPLICATION

- Load/ Power Switching
- Interfacing Switching
- Battery Management for Ultra Small Portable Electronics
- Logic Level Shift

MARKING

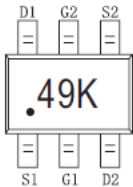

Equivalent Circuit

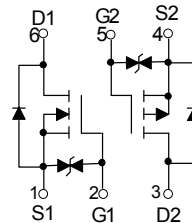

ABSOLUTE MAXIMUM RATINGS ($T_a=25^{\circ}C$ unless otherwise noted)

Parameter	Symbol	Value	Unit
N-MOSFET			
Drain-Source Voltage	V_{DS}	20	V
Typical Gate-Source Voltage	V_{GS}	±12	V
Continuous Drain Current (note 1)	I_D	0.75	A
Pulsed Drain Current ($t_p=10\mu s$)	I_{DM}	1.8	A
P-MOSFET			
Drain-Source Voltage	V_{DS}	-20	V
Typical Gate-Source Voltage	V_{GS}	±12	V
Continuous Drain Current (note 1)	I_D	-0.66	A
Pulsed Drain Current ($t_p=10\mu s$)	I_{DM}	-1.2	A
Temperature and Thermal Resistance			
Thermal Resistance from Junction to Ambient (note 1)	$R_{\theta JA}$	833	$^{\circ}C/W$
Junction Temperature	T_J	150	$^{\circ}C$
Storage Temperature	T_{STG}	-55~+150	$^{\circ}C$
Lead Temperature for Soldering Purposes(1/8" from case for 10 s)	T_L	260	$^{\circ}C$

MOSFET ELECTRICAL CHARACTERISTICS

N-ch MOSFET ELECTRICAL CHARACTERISTICS($T_a=25^\circ\text{C}$ unless otherwise noted)

Parameter	Symbol	Test Condition	Min	Typ	Max	Unit
STATIC CHARACTERISTICS						
Drain-source breakdown voltage	$V_{(BR)DSS}$	$V_{GS} = 0V, I_D = 250\mu A$	20			V
Zero gate voltage drain current	I_{DSS}	$V_{DS} = 20V, V_{GS} = 0V$			1	μA
Gate-body leakage current	I_{GSS}	$V_{GS} = \pm 10V, V_{DS} = 0V$			± 20	μA
Gate threshold voltage (note 2)	$V_{GS(th)}$	$V_{DS} = V_{GS}, I_D = 250\mu A$	0.35		1.1	V
Drain-source on-resistance(note 2)	$R_{DS(on)}$	$V_{GS} = 4.5V, I_D = 0.65A$			380	$m\Omega$
		$V_{GS} = 2.5V, I_D = 0.55A$			450	$m\Omega$
		$V_{GS} = 1.8V, I_D = 0.45A$			800	$m\Omega$
Forward tranconductance(note 2)	g_{FS}	$V_{DS} = 10V, I_D = 0.8A$		1.6		S
Diode forward voltage	V_{SD}	$I_S = 0.15A, V_{GS} = 0V$			1.2	V
DYNAMIC CHARACTERISTICS (note 4)						
Input Capacitance	C_{iss}	$V_{DS} = 16V, V_{GS} = 0V, f = 1MHz$		79	120	pF
Output Capacitance	C_{oss}			13	20	pF
Reverse Transfer Capacitance	C_{rss}			9	15	pF
SWITCHING CHARACTERISTICS (note 3,4)						
Turn-on delay time	$t_{d(on)}$	$V_{GS} = 4.5V, V_{DS} = 10V, I_D = 500mA, R_{GEN} = 10\Omega$		6.7		ns
Turn-on rise time	t_r			4.8		ns
Turn-off delay time	$t_{d(off)}$			17.3		ns
Turn-off fall time	t_f			7.4		ns

P-ch MOSFET ELECTRICAL CHARACTERISTICS($T_a=25^\circ\text{C}$ unless otherwise noted)

Parameter	Symbol	Test Condition	Min	Typ	Max	Unit
STATIC CHARACTERISTICS						
Drain-source breakdown voltage	$V_{(BR)DSS}$	$V_{GS} = 0V, I_D = -250\mu A$	-20			V
Zero gate voltage drain current	I_{DSS}	$V_{DS} = -20V, V_{GS} = 0V$			-1	μA
Gate-body leakage current	I_{GSS}	$V_{GS} = \pm 10V, V_{DS} = 0V$			± 20	μA
Gate threshold voltage (note 2)	$V_{GS(th)}$	$V_{DS} = V_{GS}, I_D = -250\mu A$	-0.35		-1.1	V
Drain-source on-resistance(note 2)	$R_{DS(on)}$	$V_{GS} = -4.5V, I_D = -1A$			520	$m\Omega$
		$V_{GS} = -2.5V, I_D = -0.8A$			700	$m\Omega$
		$V_{GS} = -1.8V, I_D = -0.5A$			950	$m\Omega$
Forward tranconductance(note 2)	g_{FS}	$V_{DS} = -10V, I_D = -0.54A$		1.2		S
Diode forward voltage	V_{SD}	$I_S = -0.5A, V_{GS} = 0V$			-1.2	V
DYNAMIC CHARACTERISTICS (note 4)						
Input Capacitance	C_{iss}	$V_{DS} = -16V, V_{GS} = 0V, f = 1MHz$		113	170	pF
Output Capacitance	C_{oss}			15	25	pF
Reverse Transfer Capacitance	C_{rss}			9	15	pF
SWITCHING CHARACTERISTICS (note 3, 4)						
Turn-on delay time	$t_{d(on)}$	$V_{GS} = -4.5V, V_{DS} = -10V, I_D = -200mA, R_{GEN} = 10\Omega$		9		ns
Turn-on rise time	t_r			5.8		ns
Turn-off delay time	$t_{d(off)}$			32.7		ns
Turn-off fall time	t_f			20.3		ns

Notes :

- 1.Surface mounted on FR4 board using the minimum recommended pad size.
2. Pulse Test : Pulse width=300 μs , duty cycle $\leq 2\%$.
3. Switching characteristics are independent of operating junction temperature.
4. Granted by design, not subject to producing.

Typical Characteristics

N-Channel MOS

Output Characteristics

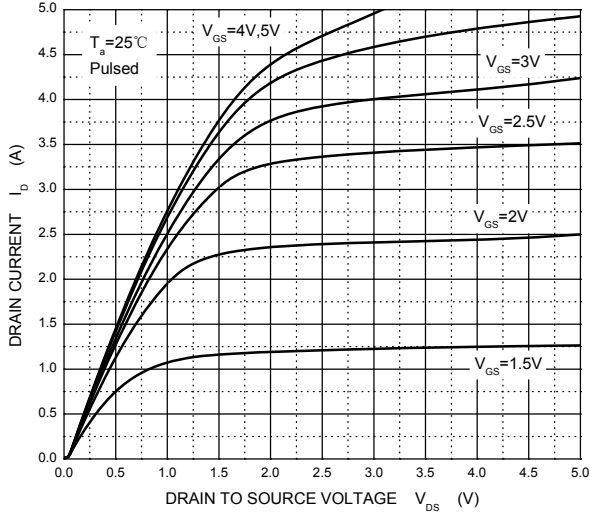

Transfer Characteristics

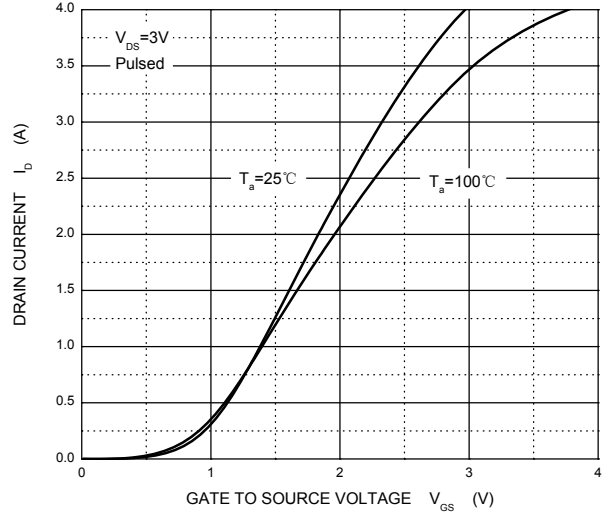

$R_{DS(ON)}$ — I_D

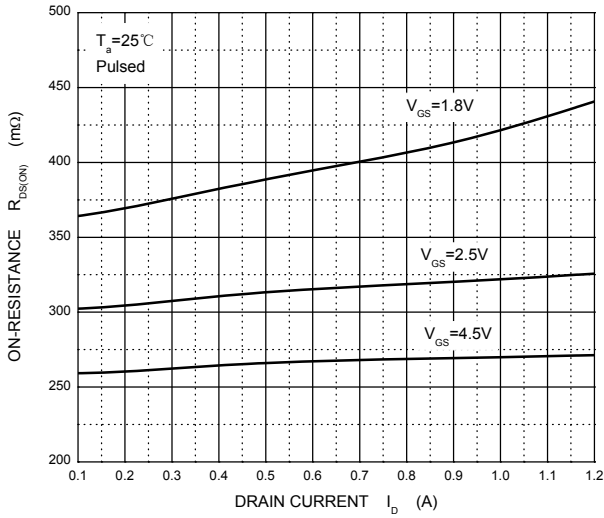

$R_{DS(ON)}$ — V_{GS}

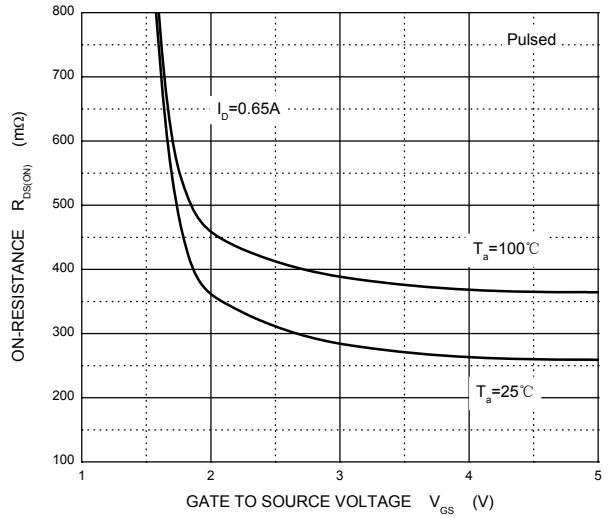

I_S — V_{SD}

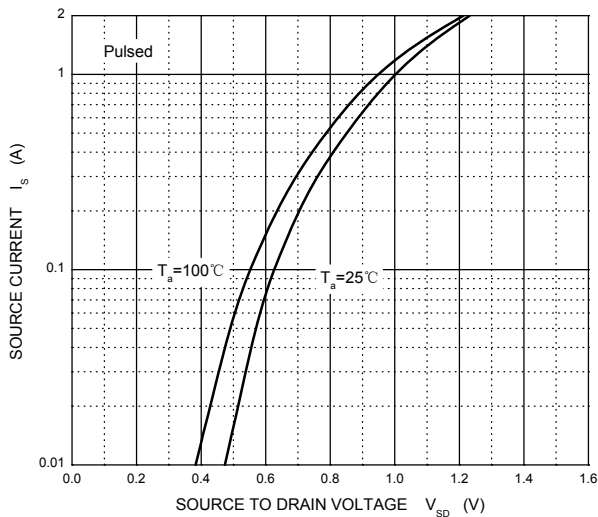

Threshold Voltage

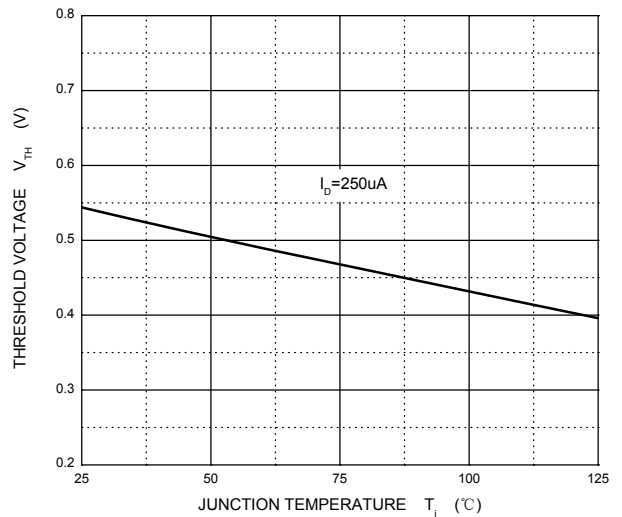

Typical Characteristics

P-Channel MOS

Output Characteristics

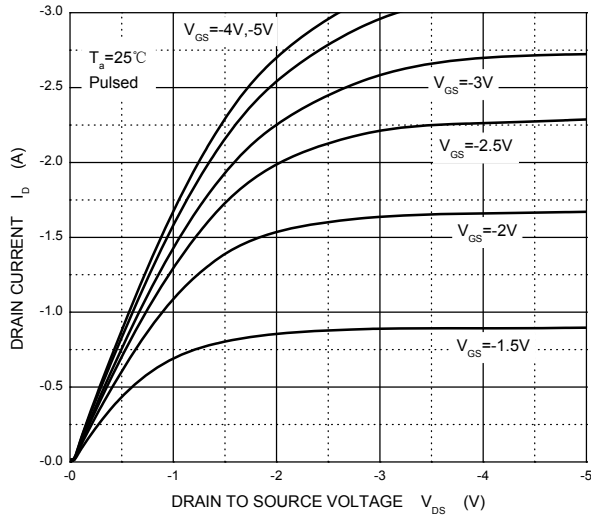

Transfer Characteristics

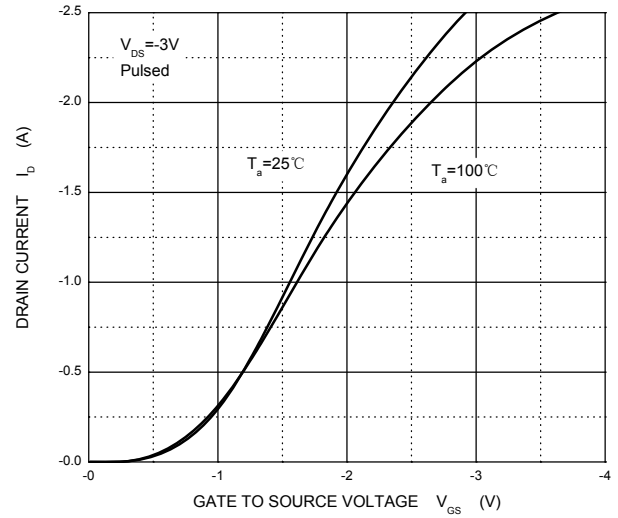

$R_{DS(ON)}$ — I_D

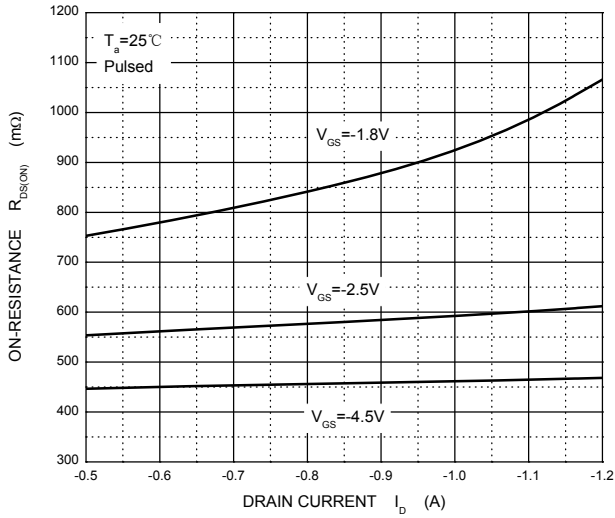

$R_{DS(ON)}$ — V_{GS}

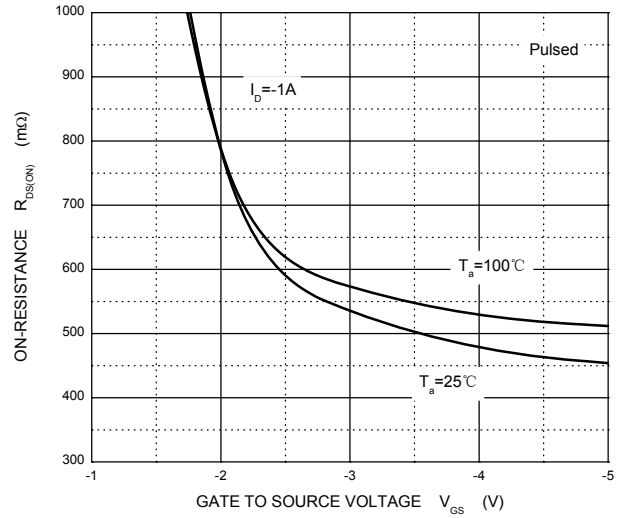

I_S — V_{SD}

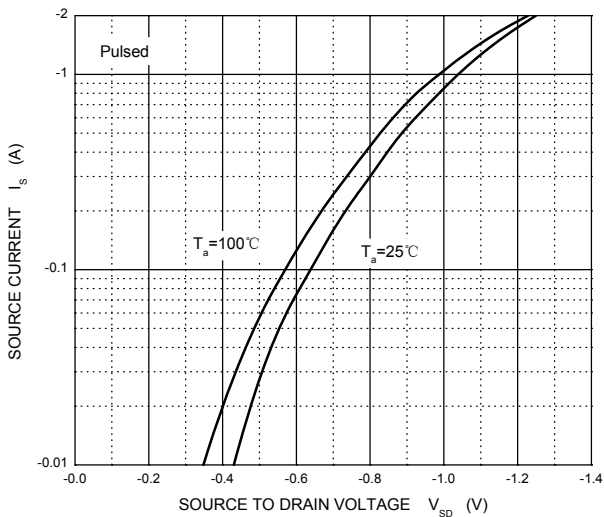

Threshold Voltage

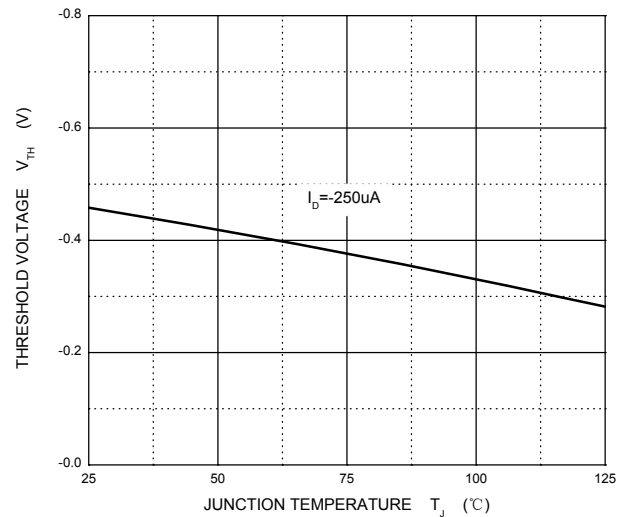

SOT-363 Package Outline Dimensions

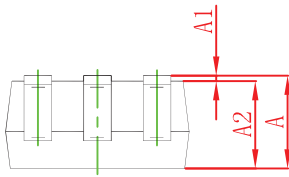
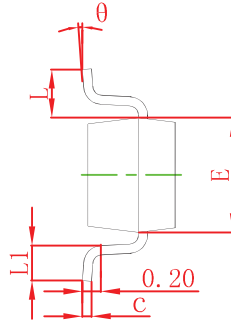
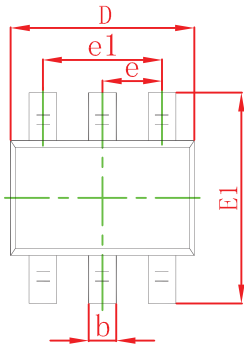

Symbol	Dimensions In Millimeters		Dimensions In Inches	
	Min	Max	Min	Max
A	0.900	1.100	0.035	0.043
A1	0.000	0.100	0.000	0.004
A2	0.900	1.000	0.035	0.039
b	0.150	0.350	0.006	0.014
c	0.100	0.150	0.004	0.006
D	2.000	2.200	0.079	0.087
E	1.150	1.350	0.045	0.053
E1	2.150	2.400	0.085	0.094
e	0.650 TYP		0.026 TYP	
e1	1.200	1.400	0.047	0.055
L	0.525 REF		0.021 REF	
L1	0.260	0.460	0.010	0.018
θ	0°	8°	0°	8°

SOT-363 Suggested Pad Layout

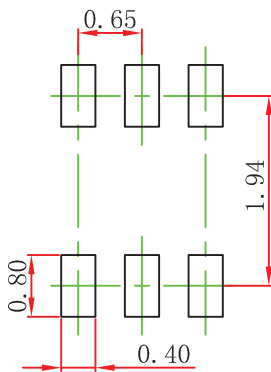

Note:

1. Controlling dimension: in millimeters.
2. General tolerance: $\pm 0.05\text{mm}$.
3. The pad layout is for reference purposes only.

NOTICE

JCET reserve the right to make modifications, enhancements, improvements, corrections or other changes without further notice to any product herein. JCET does not assume any liability arising out of the application or use of any product described herein.

SOT-363 Tape and reel

SOT-363 Embossed Carrier Tape

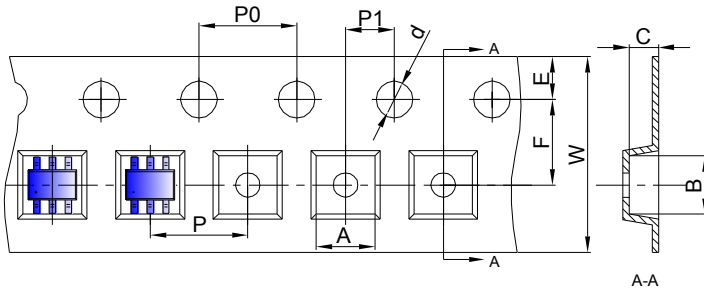

Packaging Description:

SOT-363 parts are shipped in tape. The carrier tape is made from a dissipative (carbon filled) polycarbonate resin. The cover tape is a multilayer film (Heat Activated Adhesive in nature) primarily composed of polyester film, adhesive layer, sealant, and anti-static sprayed agent. These reeled parts in standard option are shipped with 3,000 units per 7" or 17.8cm diameter reel. The reels are clear in color and is made of polystyrene plastic (anti-static coated).

Dimensions are in millimeter										
Pkg type	A	B	C	d	E	F	P0	P	P1	W
SOT-363	2.25	2.55	1.20	Ø1.50	1.75	3.50	4.00	4.00	2.00	8.00

SOT-363 Tape Leader and Trailer

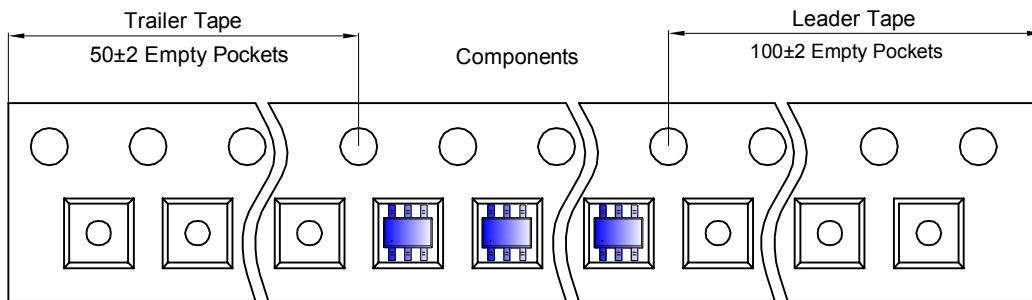

SOT-363 Reel

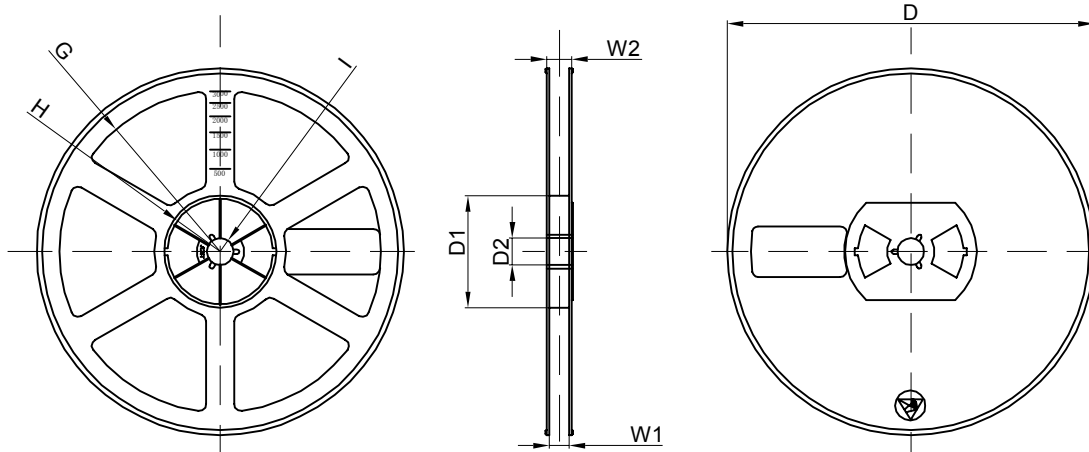

Dimensions are in millimeter								
Reel Option	D	D1	D2	G	H	I	W1	W2
7" Dia	Ø178.00	54.40	13.00	R78.00	R25.60	R6.50	9.50	12.30

REEL	Reel Size	Box	Box Size(mm)	Carton	Carton Size(mm)	G.W.(kg)
3000 pcs	7 inch	30,000 pcs	203×203×195	120,000 pcs	438×438×220	