



CEP9060N/CEB9060N

CEF9060N

N-Channel Enhancement Mode Field Effect Transistor

FEATURES

Type	V _{DSS}	R _{DS(ON)}	I _D	@V _{GS}
CEP9060N	55V	10.5mΩ	90A	10V
CEB9060N	55V	10.5mΩ	90A	10V
CEF9060N	55V	10.5mΩ	90A ^e	10V

- Super high dense cell design for extremely low R_{DS(ON)}.
- High power and current handling capability.
- Lead free product is acquired.
- TO-220 & TO-263 package & TO-220F full-pak for through hole.

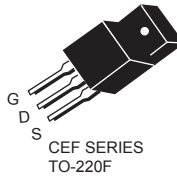

ABSOLUTE MAXIMUM RATINGS $T_C = 25^\circ\text{C}$ unless otherwise noted

Parameter	Symbol	Limit		Units
		TO-220/263	TO-220F	
Drain-Source Voltage	V _{DS}	55		V
Gate-Source Voltage	V _{GS}	±20		V
Drain Current-Continuous	I _D	90	90 ^e	A
Drain Current-Pulsed ^a	I _{DM} ^f	360	360 ^e	A
Maximum Power Dissipation @ T _C = 25°C - Derate above 25°C	P _D	166	49	W
		1.11	0.33	W/°C
Single Pulsed Avalanche Energy ^d	E _{AS}	325	325	mJ
Single Pulsed Avalanche Current ^d	I _{AS}	50	50	A
Operating and Store Temperature Range	T _J , T _{stg}	-55 to 175		°C

Thermal Characteristics

Parameter	Symbol	Limit		Units
Thermal Resistance, Junction-to-Case	R _{θJC}	0.9	3	°C/W
Thermal Resistance, Junction-to-Ambient	R _{θJA}	62.5	65	°C/W



CEP9060N/CEB9060N

CEF9060N

Electrical Characteristics $T_C = 25^\circ\text{C}$ unless otherwise noted

4

Parameter	Symbol	Test Condition	Min	Typ	Max	Units
Off Characteristics						
Drain-Source Breakdown Voltage	BV_{DSS}	$V_{GS} = 0V, I_D = 250\mu A$	55			V
Zero Gate Voltage Drain Current	I_{DSS}	$V_{DS} = 55V, V_{GS} = 0V$			25	μA
Gate Body Leakage Current, Forward	I_{GSSF}	$V_{GS} = 20V, V_{DS} = 0V$			100	nA
Gate Body Leakage Current, Reverse	I_{GSSR}	$V_{GS} = -20V, V_{DS} = 0V$			-100	nA
On Characteristics^b						
Gate Threshold Voltage	$V_{GS(th)}$	$V_{GS} = V_{DS}, I_D = 250\mu A$	2		4	V
Static Drain-Source On-Resistance	$R_{DS(on)}$	$V_{GS} = 10V, I_D = 62A$		8.5	10.5	m Ω
Forward Transconductance	g_{FS}	$V_{DS} = 25V, I_D = 62A$		30		S
Dynamic Characteristics^c						
Input Capacitance	C_{iss}	$V_{DS} = 25V, V_{GS} = 0V, f = 1.0\text{ MHz}$		3695		pF
Output Capacitance	C_{oss}			765		pF
Reverse Transfer Capacitance	C_{riss}			60		pF
Switching Characteristics^c						
Turn-On Delay Time	$t_{d(on)}$	$V_{DD} = 28V, I_D = 62A, V_{GS} = 10V, R_{GEN} = 4.5\Omega$		24	48	ns
Turn-On Rise Time	t_r			11.9	23.8	ns
Turn-Off Delay Time	$t_{d(off)}$			60	120	ns
Turn-Off Fall Time	t_f			19	38 <input type="checkbox"/>	ns
Total Gate Charge	Q_g	$V_{DS} = 44V, I_D = 62A, V_{GS} = 10V$		68.1	90.5	nC
Gate-Source Charge	Q_{gs}			12.6		nC
Gate-Drain Charge	Q_{gd}			22.7		nC
Drain-Source Diode Characteristics and Maximum Ratings						
Drain-Source Diode Forward Current	I_S				62	A
Drain-Source Diode Forward Voltage ^b	V_{SD}	$V_{GS} = 0V, I_S = 62A$			1.3	V
Notes : <input type="checkbox"/> a.Repetitive Rating : Pulse width limited by maximum junction temperature b.Pulse Test : Pulse Width $\leq 300\mu s$, Duty Cycle $\leq 2\%$. <input type="checkbox"/> c.Guaranteed by design, not subject to production testing. <input type="checkbox"/> d.L = 260 μH , $I_{AS} = 50A, V_{DD} = 24V, R_G = 25\Omega$, Starting $T_J = 25^\circ\text{C}$ e.Limited only by maximum temperature allowed . f.Pulse width limited by safe operating area .						



CEP9060N/CEB9060N

CEF9060N

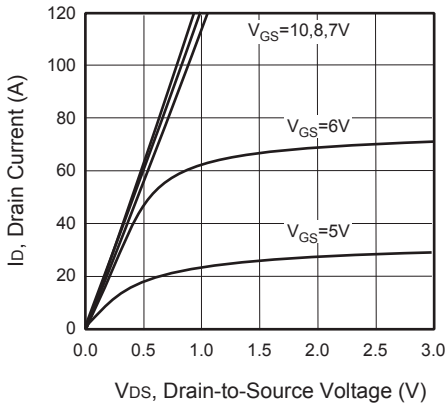

Figure 1. Output Characteristics

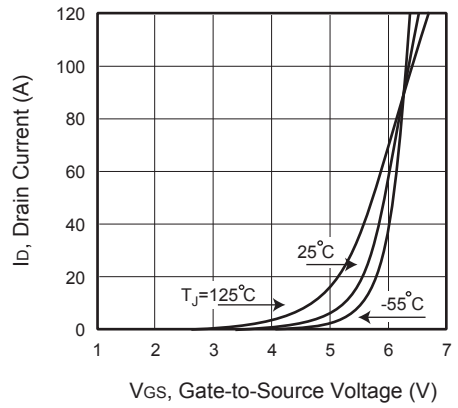

Figure 2. Transfer Characteristics

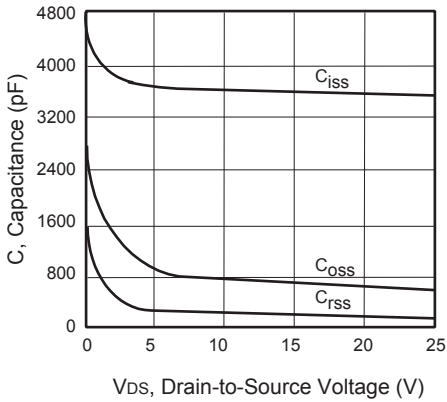

Figure 3. Capacitance

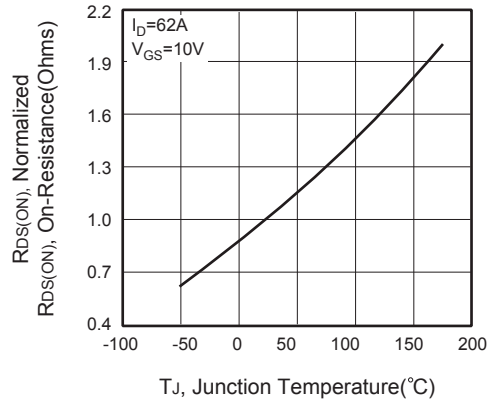

Figure 4. On-Resistance Variation with Temperature



Figure 5. Gate Threshold Variation with Temperature

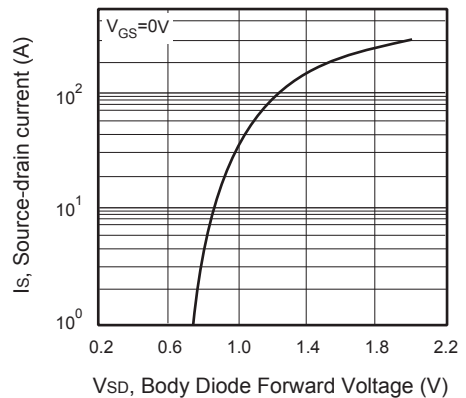

Figure 6. Body Diode Forward Voltage Variation with Source Current



CEP9060N/CEB9060N

CEF9060N

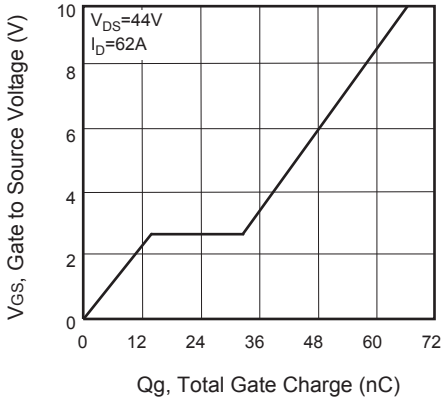

Figure 7. Gate Charge

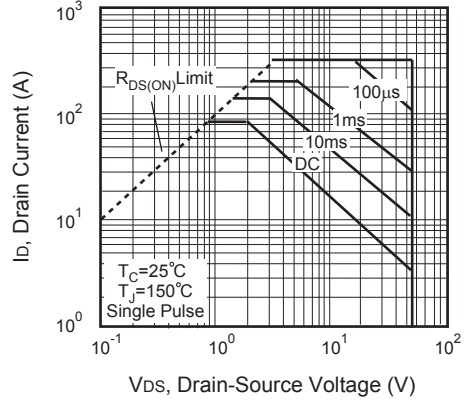

Figure 8. Maximum Safe Operating Area

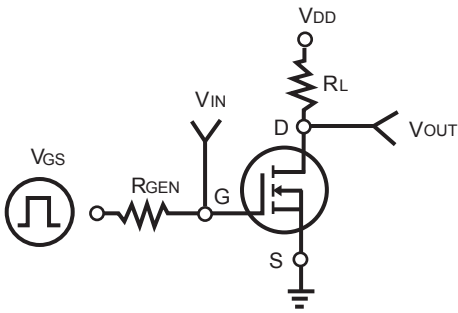

Figure 9. Switching Test Circuit

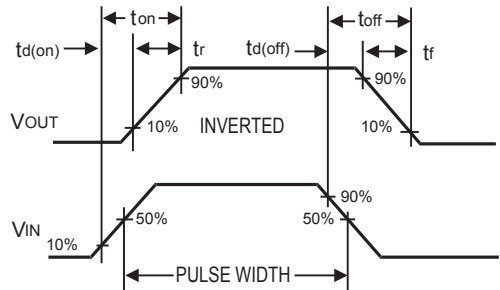

Figure 10. Switching Waveforms

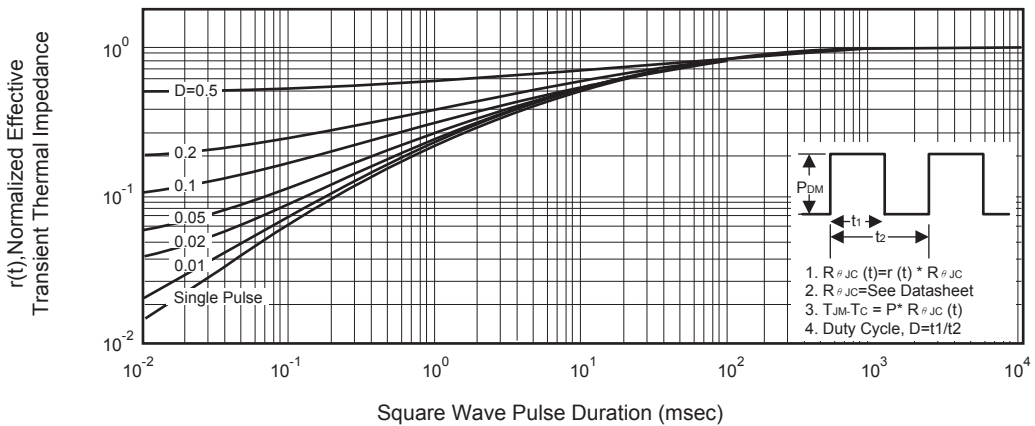

Figure 11. Normalized Thermal Transient Impedance Curve