

BCX56U

NPN Silicon Epitaxial Planar Transistor

Medium Power Transistor

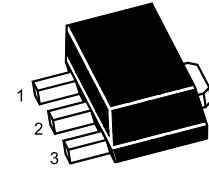

1.Base 2.Collector 3.Emitter
SOT-89 Plastic Package

Absolute Maximum Ratings ($T_a = 25^\circ\text{C}$)

Parameter	Symbol	Value	Unit
Collector Base Voltage	V_{CBO}	100	V
Collector Emitter Voltage	V_{CEO}	80	V
Emitter Base Voltage	V_{EBO}	5	V
Collector Current	I_C	1	A
Peak Collector Current	I_{CM}	1.5	A
Total Power Dissipation	P_{tot}	0.5 ¹⁾ 1.3 ²⁾	W
Junction Temperature	T_j	150	$^\circ\text{C}$
Storage Temperature Range	T_{stg}	- 65 to + 150	$^\circ\text{C}$

¹⁾ Device mounted on an FR4 Printed-Circuit Board(PCB), single-sided copper, tin-plated and standard footprint.

²⁾ Device mounted on an FR4 PCB, single-sided copper, tin-plated, mounting pad for collector 6 cm²

Characteristics at $T_a = 25^\circ\text{C}$

Parameter	Symbol	Min.	Typ.	Max.	Unit
DC Current Gain at $V_{CE} = 2\text{ V}$, $I_C = 5\text{ mA}$ at $V_{CE} = 2\text{ V}$, $I_C = 150\text{ mA}$ at $V_{CE} = 2\text{ V}$, $I_C = 500\text{ mA}$	h_{FE}	40	-	-	-
	h_{FE}	63	-	160	-
	h_{FE}	100	-	250	-
	h_{FE}	25	-	-	-
Collector Base Cutoff Current at $V_{CB} = 30\text{ V}$	I_{CBO}	-	-	100	nA
Emitter Base Cutoff Current at $V_{EB} = 5\text{ V}$	I_{EBO}	-	-	100	nA
Collector Base Breakdown Voltage at $I_C = 100\text{ }\mu\text{A}$	$V_{(BR)CBO}$	100	-	-	V
Collector Emitter Breakdown Voltage at $I_C = 1\text{ mA}$	$V_{(BR)CEO}$	80	-	-	V
Emitter Base Breakdown Voltage at $I_E = 100\text{ }\mu\text{A}$	$V_{(BR)EBO}$	5	-	-	V
Collector Emitter Saturation Voltage at $I_C = 500\text{ mA}$, $I_B = 50\text{ mA}$	$V_{CE(sat)}$	-	-	0.5	V
Base Emitter Voltage at $V_{CE} = 2\text{ V}$, $I_C = 500\text{ mA}$	V_{BE}	-	-	1	V
Transition Frequency at $V_{CE} = 5\text{ V}$, $I_C = 50\text{ mA}$, $f = 100\text{ MHz}$	f_T	100	-	-	MHz
Collector Capacitance at $V_{CB} = 10\text{ V}$, $f = 1\text{ MHz}$	C_c	-	6	-	pF

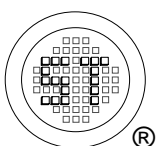

SEMTECH ELECTRONICS LTD.



ISO 9001 : 2008
Certificate No. 160713000



ISO 14001 : 2004
Certificate No. 7116



ISO 9001 : 2008
Certificate No. 50713410



BS OHSAS 18001 : 2007
Certificate No. 7116



IECQ QC 080000
Certificate No. PFC-HSP4-1484

BCX56U

Static Characteristics

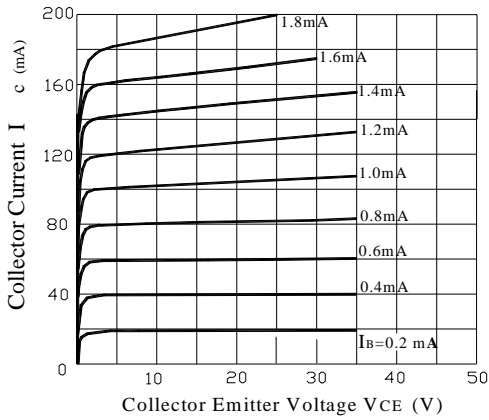

DC Current Gain

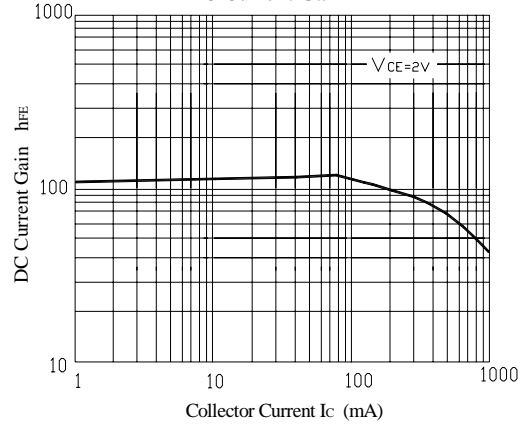

Base Emitter Saturation Voltage
Collector Emitter Saturation Voltage

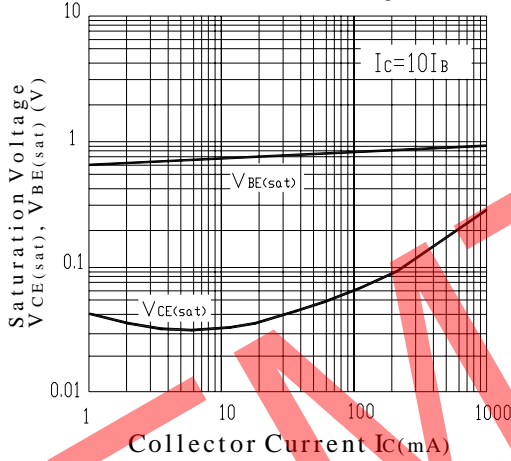

Base Emitter On Voltage

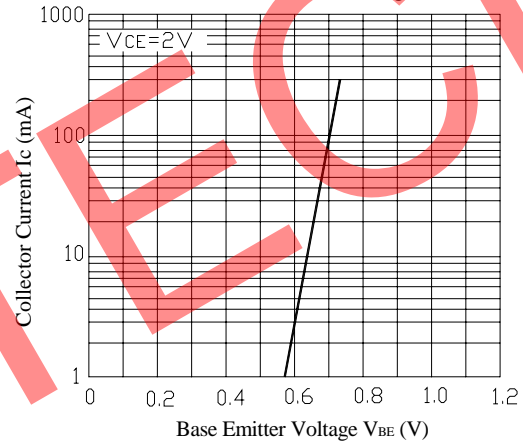

Collector Output Capacitance

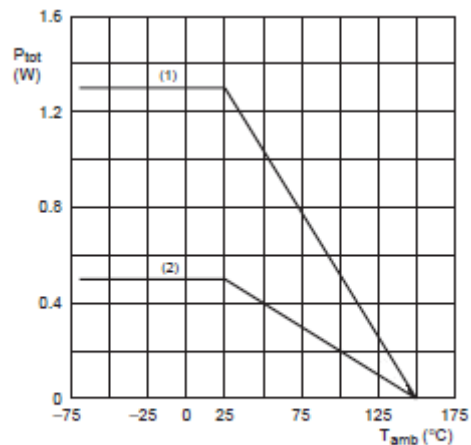
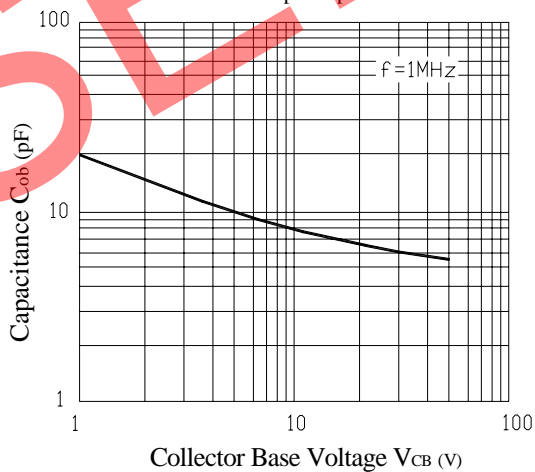

- (1) FR4 PCB, mounting pad for collector 8 cm²
- (2) FR4 PCB, standard footprint

Power derating curves

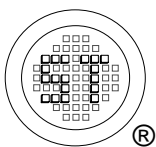

SEMTECH ELECTRONICS LTD.



BCX56U

SOT-89 PACKAGE OUTLINE

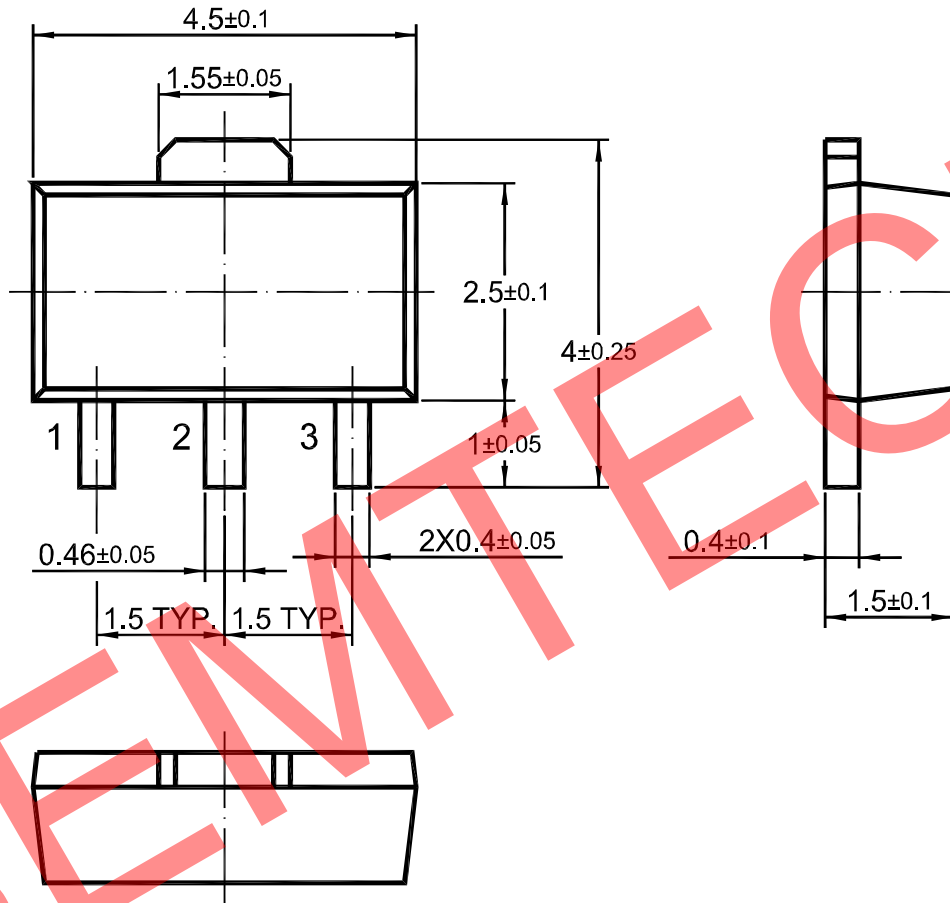

Dimensions in mm

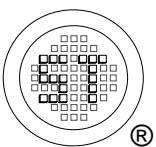

SEMTECH ELECTRONICS LTD.



Dated: 27/12/2013 Rev: 02