

SOT-23 Plastic-Encapsulate Transistors

BCV47 TRANSISTOR (NPN)

FEATURES

- High Collector Current
- High Current Gain

MARKING:FG

MAXIMUM RATINGS ($T_a=25^{\circ}\text{C}$ unless otherwise noted)

| Symbol | Parameter | Value | Unit |
|-----------------|---|----------|-----------------------------|
| V_{CBO} | Collector-Base Voltage | 80 | V |
| V_{CEO} | Collector-Emitter Voltage | 60 | V |
| V_{EBO} | Emitter-Base Voltage | 10 | V |
| I_C | Collector Current | 500 | mA |
| P_C | Collector Power Dissipation | 300 | mW |
| $R_{\theta JA}$ | Thermal Resistance From Junction To Ambient | 416 | $^{\circ}\text{C}/\text{W}$ |
| T_j | Junction Temperature | 150 | $^{\circ}\text{C}$ |
| T_{stg} | Storage Temperature | -55~+150 | $^{\circ}\text{C}$ |

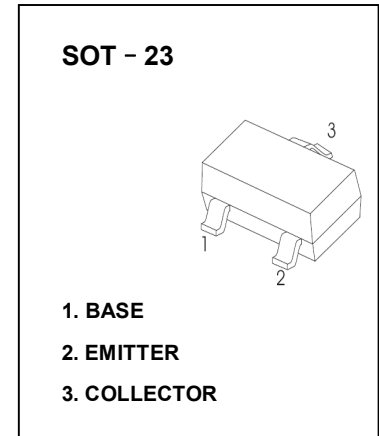

ELECTRICAL CHARACTERISTICS ($T_a=25^{\circ}\text{C}$ unless otherwise specified)

| Parameter | Symbol | Test conditions | Min | Typ | Max | Unit |
|--------------------------------------|---------------|--|-------|-----|-----|---------------|
| Collector-base breakdown voltage | $V_{(BR)CBO}$ | $I_C=100\mu\text{A}, I_E=0$ | 80 | | | V |
| Collector-emitter breakdown voltage | $V_{(BR)CEO}$ | $I_C=10\text{mA}, I_B=0$ | 60 | | | V |
| Emitter-base breakdown voltage | $V_{(BR)EBO}$ | $I_E=10\mu\text{A}, I_C=0$ | 10 | | | V |
| Collector cut-off current | I_{CBO} | $V_{CB}=60\text{V}, I_E=0$ | | | 0.1 | μA |
| Emitter cut-off current | I_{EBO} | $V_{EB}=4\text{V}, I_C=0$ | | | 0.1 | μA |
| DC current gain | $h_{FE(1)}$ | $V_{CE}=1\text{V}, I_C=100\mu\text{A}$ | 2000 | | | |
| | $h_{FE(2)}$ | $V_{CE}=5\text{V}, I_C=10\text{mA}$ | 4000 | | | |
| | $h_{FE(3)}$ | $V_{CE}=5\text{V}, I_C=100\text{mA}$ | 10000 | | | |
| | $h_{FE(4)}$ | $V_{CE}=5\text{V}, I_C=0.5\text{A}$ | 2000 | | | |
| Collector-emitter saturation voltage | $V_{CE(sat)}$ | $I_C=100\text{mA}, I_B=0.1\text{mA}$ | | | 1 | V |
| Base-emitter saturation voltage | $V_{BE(sat)}$ | $I_C=100\text{mA}, I_B=0.1\text{mA}$ | | | 1.5 | V |
| Transition frequency | f_T | $V_{CE}=5\text{V}, I_C=50\text{mA}, f=100\text{MHz}$ | | 170 | | MHz |
| Collector output capacitance | C_{ob} | $V_{CB}=10\text{V}, I_E=0, f=1\text{MHz}$ | | 3.5 | | pF |

Typical Characteristics

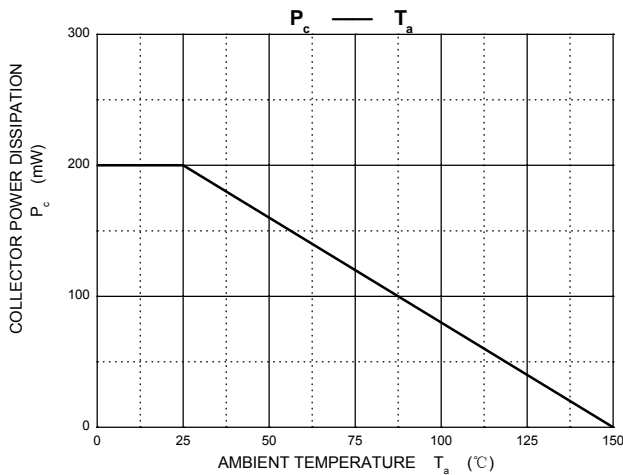
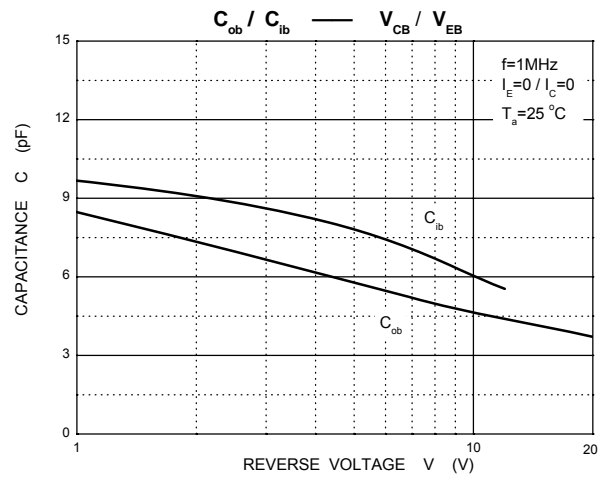
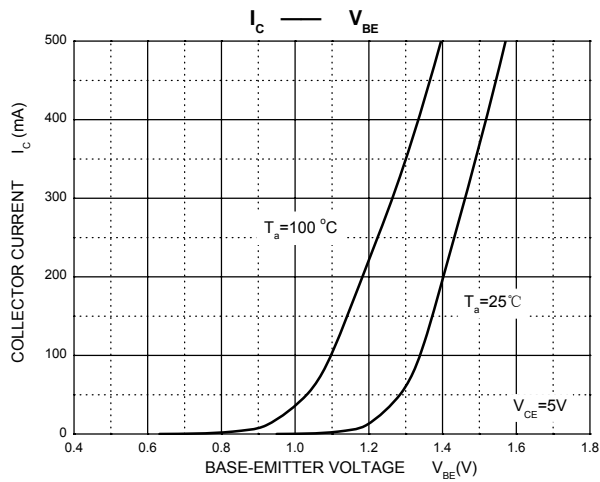
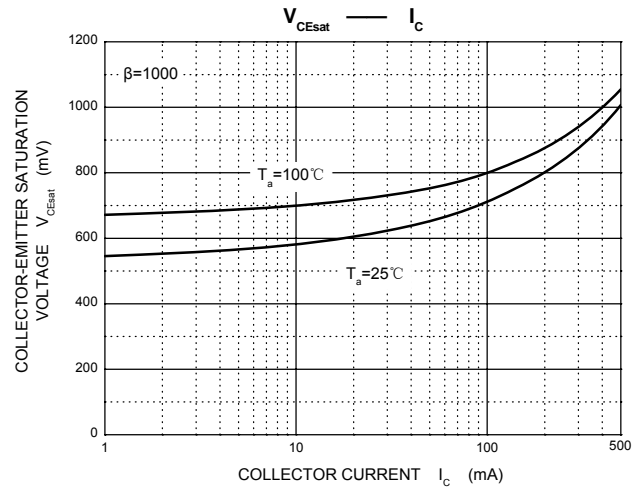
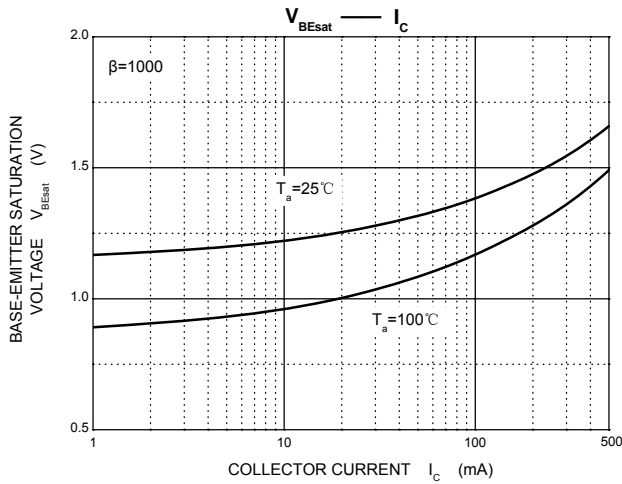
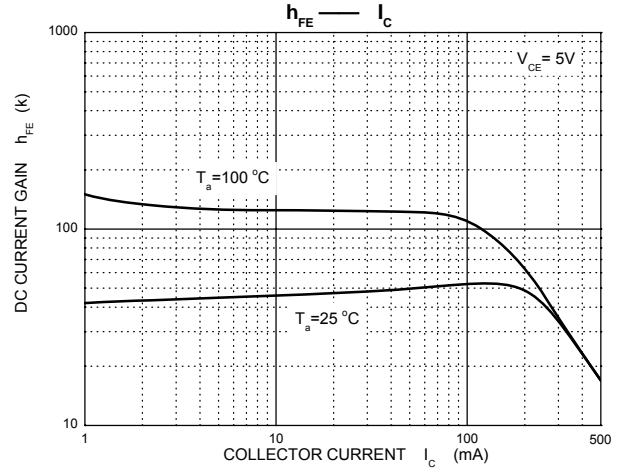
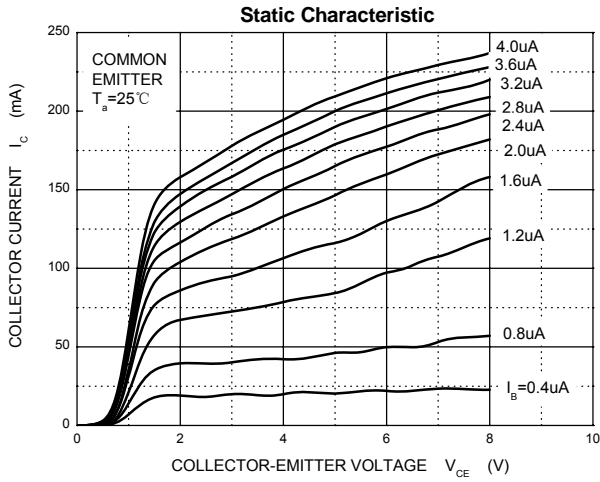

SOT-23 Package Outline Dimensions

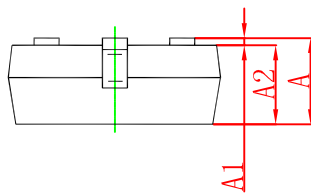
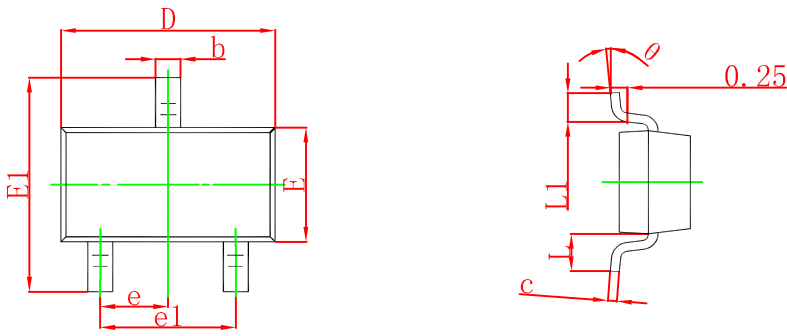

| Symbol | Dimensions In Millimeters | | Dimensions In Inches | |
|--------|---------------------------|-------|----------------------|-------|
| | Min | Max | Min | Max |
| A | 0.900 | 1.150 | 0.035 | 0.045 |
| A1 | 0.000 | 0.100 | 0.000 | 0.004 |
| A2 | 0.900 | 1.050 | 0.035 | 0.041 |
| b | 0.300 | 0.500 | 0.012 | 0.020 |
| c | 0.080 | 0.150 | 0.003 | 0.006 |
| D | 2.800 | 3.000 | 0.110 | 0.118 |
| E | 1.200 | 1.400 | 0.047 | 0.055 |
| E1 | 2.250 | 2.550 | 0.089 | 0.100 |
| e | 0.950 TYP | | 0.037 TYP | |
| e1 | 1.800 | 2.000 | 0.071 | 0.079 |
| L | 0.550 REF | | 0.022 REF | |
| L1 | 0.300 | 0.500 | 0.012 | 0.020 |
| θ | 0° | 8° | 0° | 6° |

SOT-23 Suggested Pad Layout

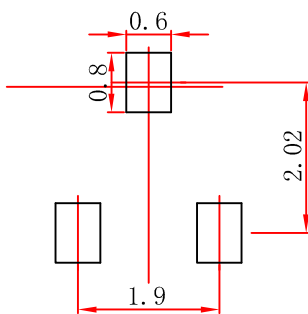

Note:

1. Controlling dimension: in millimeters.
2. General tolerance: $\pm 0.05\text{mm}$.
3. The pad layout is for reference purposes only.

NOTICE

JCET reserve the right to make modifications, enhancements, improvements, corrections or other changes without further notice to any product herein. JCET does not assume any liability arising out of the application or use of any product described herein.

SOT-23 Tape and Reel

SOT-23 Embossed Carrier Tape

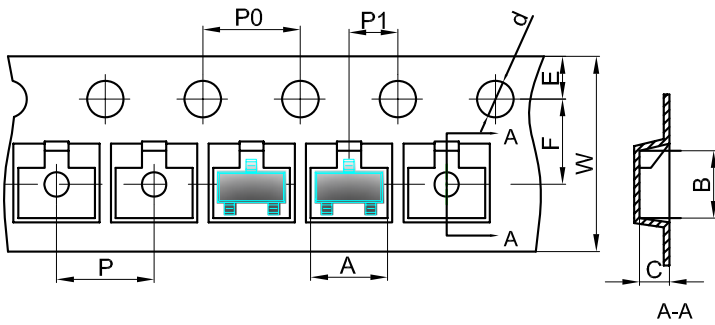

Packaging Description:
 SOT-23 parts are shipped in tape. The carrier tape is made from a dissipative (carbon filled) polycarbonate resin. The cover tape is a multilayer film (Heat Activated Adhesive in nature) primarily composed of polyester film, adhesive layer, sealant, and anti-static sprayed agent. These reeled parts in standard option are shipped with 3,000 units per 7" or 17.8cm diameter reel. The reels are clear in color and is made of polystyrene plastic (anti-static coated).

| Dimensions are in millimeter | | | | | | | | | | |
|------------------------------|--------|--------|--------|--------|--------|--------|--------|--------|--------|-----------|
| Pkg type | A | B | C | d | E | F | P0 | P | P1 | W |
| SOT-23 | 3.15 | 2.77 | 1.22 | Ø1.50 | 1.75 | 3.50 | 4.00 | 4.00 | 2.00 | 8.00 |
| (Tolerance) | +/-0.1 | +/-0.1 | +/-0.1 | +/-0.1 | +/-0.1 | +/-0.1 | +/-0.1 | +/-0.1 | +/-0.1 | +0.3/-0.1 |

SOT-23 Tape Leader and Trailer

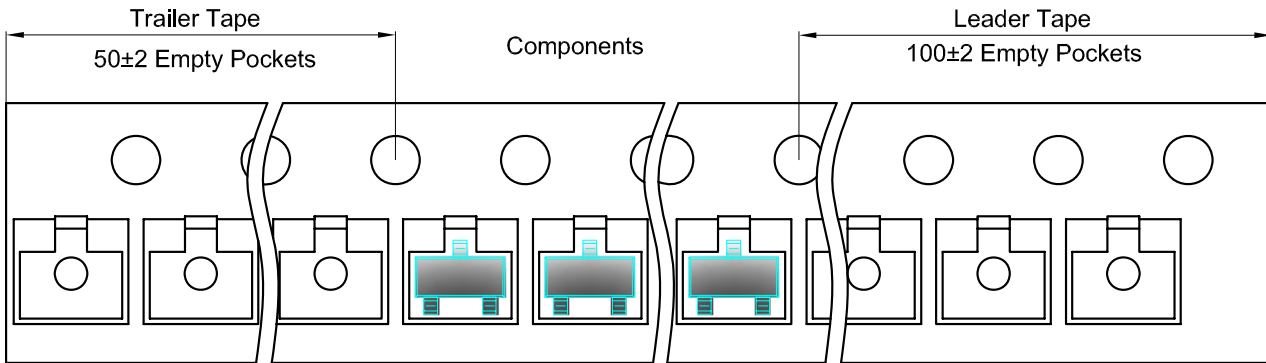

SOT-23 Reel

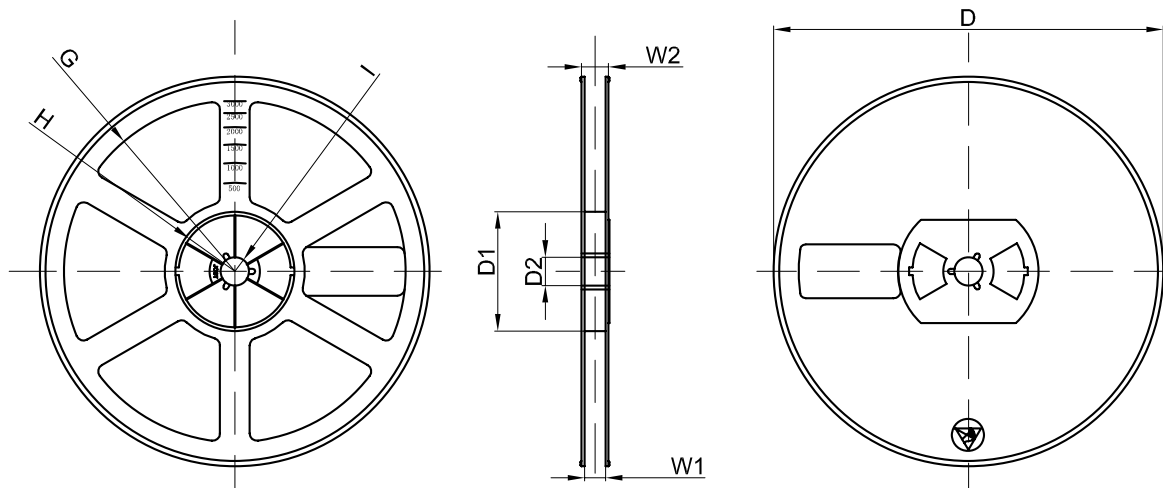

| Dimensions are in millimeter | | | | | | | | |
|------------------------------|---------|-------|-------|--------|--------|-------|------|-------|
| Reel Option | D | D1 | D2 | G | H | I | W1 | W2 |
| 7" Dia | Ø178.00 | 54.40 | 13.00 | R78.00 | R25.60 | R6.50 | 9.50 | 12.30 |
| Tolerance | +/-2 | +/-1 | +/-1 | +/-1 | +/-1 | +/-1 | +/-1 | +/-1 |

| REEL | Reel Size | Box | Box Size(mm) | Carton | Carton Size(mm) | G.W.(kg) |
|----------|-----------|------------|--------------|-------------|-----------------|----------|
| 3000 pcs | 7 inch | 45,000 pcs | 203×203×195 | 180,000 pcs | 438×438×220 | |