

TO-92 Plastic-Encapsulate Transistors

BC337/BC338 TRANSISTOR (NPN)

FEATURES

- Power dissipation

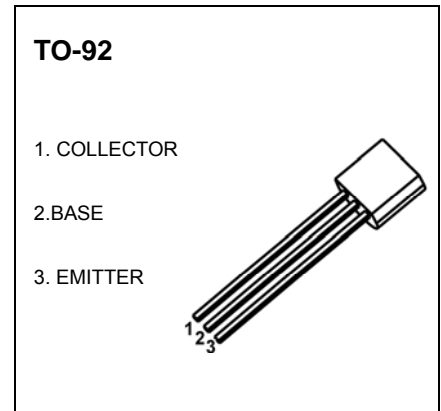

MARKING

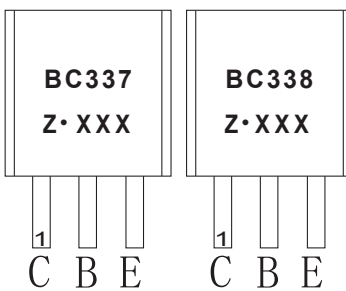

BC337,BC338=Device code

Solid dot=Green molding compound device,
if none,the normal device

Z=Rank of h_{FE}

XXX=Code

Equivalent Circuit

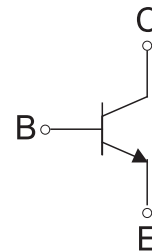

ORDERING INFORMATION

Part Number	Package	Packing Method	Pack Quantity
BC337	TO-92	Bulk	1000pcs/Bag
BC337-TA	TO-92	Tape	2000pcs/Box
BC338	TO-92	Bulk	1000pcs/Bag
BC338-TA	TO-92	Tape	2000pcs/Box

MAXIMUM RATINGS ($T_a=25^{\circ}\text{C}$ unless otherwise noted)

Symbol	Parameter	Value	Unit
V_{CBO}	Collector-Base Voltage	BC337	50
		BC338	30
V_{CEO}	Collector-Emitter Voltage	BC337	45
		BC338	25
V_{EBO}	Emitter-Base Voltage	5	V
I_C	Collector Current -Continuous	800	mA
P_D	Total Device Dissipation	625	mW
T_j	Junction Temperature	150	$^{\circ}\text{C}$
T_{stg}	Storage Temperature	-55-150	$^{\circ}\text{C}$

ELECTRICAL CHARACTERISTICS

$T_a=25^\circ\text{C}$ unless otherwise specified

Parameter	Symbol	Test conditions	MIN	TYP	MAX	UNIT
Collector-base breakdown voltage BC337 BC338	V_{CBO}	$I_C=100\mu\text{A}, I_E=0$	50 30			V V
Collector-emitter breakdown voltage BC337 BC338	V_{CEO}	$I_C=10\text{mA}, I_B=0$	45 25			V V
Emitter-base breakdown voltage	V_{EBO}	$I_E=10\mu\text{A}, I_C=0$	5			V
Collector cut-off current BC337 BC338	I_{CBO}	$V_{CB}=45\text{V}, I_E=0$ $V_{CB}=25\text{V}, I_E=0$			0.1 0.1	μA
Collector cut-off current BC337 BC338	I_{CEO}	$V_{CE}=40\text{V}, I_B=0$ $V_{CE}=20\text{V}, I_B=0$			0.2 0.2	μA
Emitter cut-off current	I_{EBO}	$V_{EB}=4\text{V}, I_C=0$			0.1	μA
BC337/BC338 BC337-16/BC338-16 BC337-25/BC338-25 BC337-40/BC338-40	$h_{FE(1)}$	$V_{CE}=1\text{V}, I_C=100\text{mA}$	100 100 160 250		630 250 400 630	
DC current gain	$h_{FE(2)}$	$V_{CE}=1\text{V}, I_C=300\text{mA}$	60			
Collector-emitter saturation voltage	$V_{CE(sat)}$	$I_C=500\text{mA}, I_B=50\text{mA}$			0.7	V
Base-emitter saturation voltage	$V_{BE(sat)}$	$I_C=500\text{mA}, I_B=50\text{mA}$			1.2	V
Base-emitter voltage	V_{BE}	$V_{CE}=1\text{V}, I_C=300\text{mA}$			1.2	V
Transition frequency	f_T	$V_{CE}=5\text{V}, I_C=10\text{mA}$ $f=100\text{MHz}$	210			MHz
Collector Output Capacitance	C_{ob}	$V_{CB}=10\text{V}, I_E=0$ $f=1\text{MHz}$		15		pF

Typical Characteristics

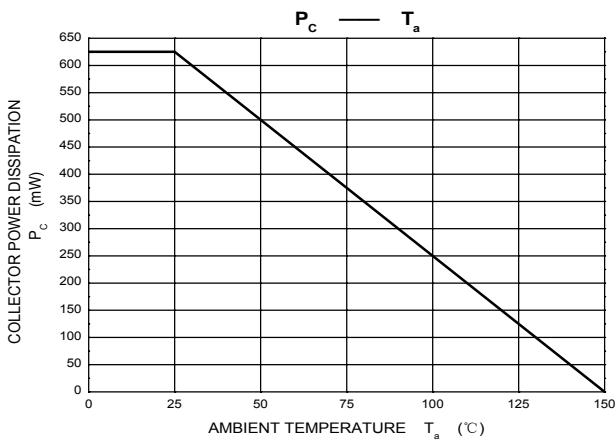
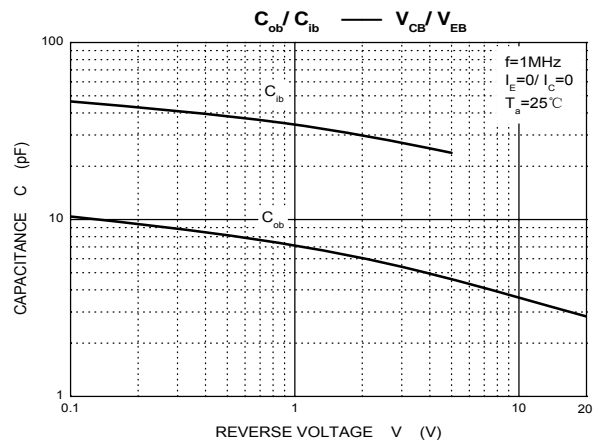
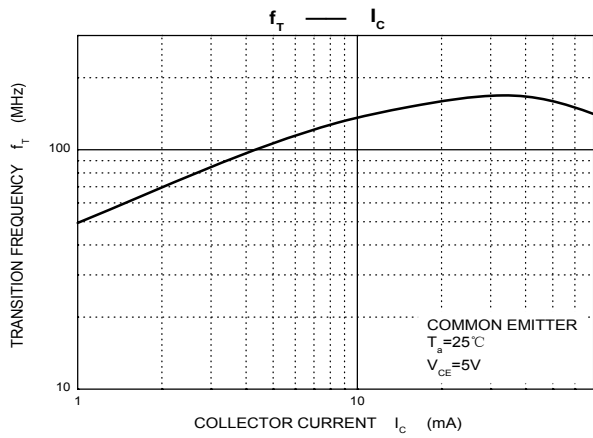
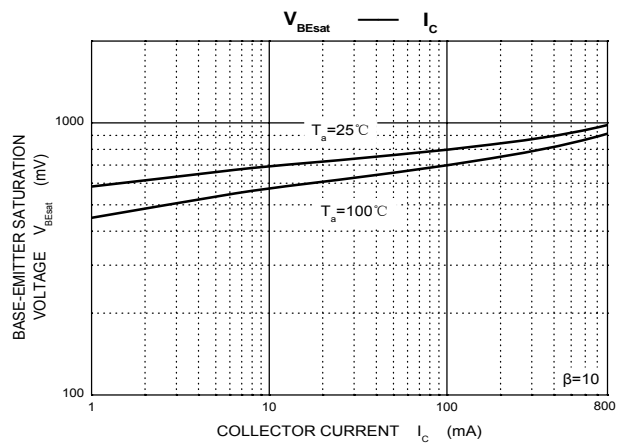
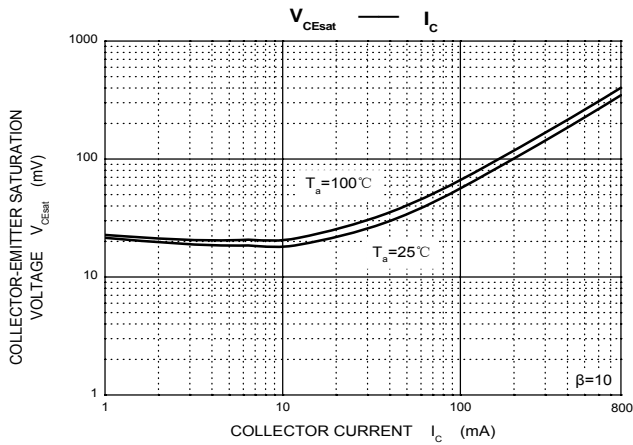
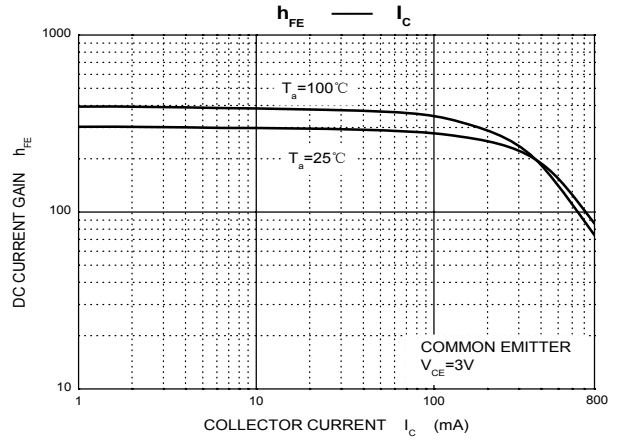
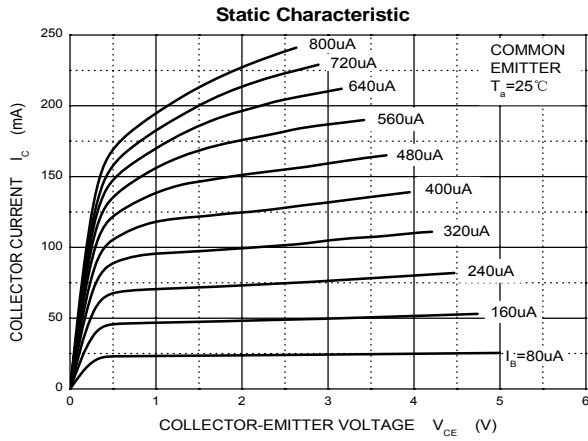

TO-92 Package Outline Dimensions

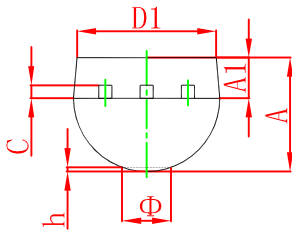

Symbol	Dimensions In Millimeters		Dimensions In Inches	
	Min	Max	Min	Max
A	3.300	3.700	0.130	0.146
A1	1.100	1.400	0.043	0.055
b	0.380	0.550	0.015	0.022
c	0.360	0.510	0.014	0.020
D	4.300	4.700	0.169	0.185
D1	3.430		0.135	
E	4.300	4.700	0.169	0.185
e	1.270 TYP		0.050 TYP	
e1	2.440	2.640	0.096	0.104
L	14.100	14.500	0.555	0.571
Φ		1.600		0.063
h	0.000	0.380	0.000	0.015

TO-92 Suggested Pad Layout

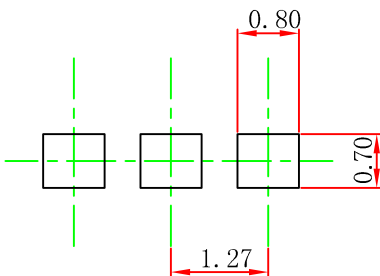

Note:

1. Controlling dimension: in millimeters.
2. General tolerance: $\pm 0.05\text{mm}$.
3. The pad layout is for reference purposes only.

NOTICE

JCET reserve the right to make modifications, enhancements, improvements, corrections or other changes without further notice to any product herein. JCET does not assume any liability arising out of the application or use of any product described herein.

TO-92 PACKAGE TAPEING DIMENSION



Dimiensions are in millimeter								
A1	A	T	P	P0	P2	F1	F2	W
4.5	4.5	3.5	12.7	12.7	6.35	2.5	2.5	18.0
W0	W1	W2	H	H0	D0	t1	t2	ΔP
6.0	9.0	1.0 MAX.	19.0	16.0	4.0	0.4	0.2	0

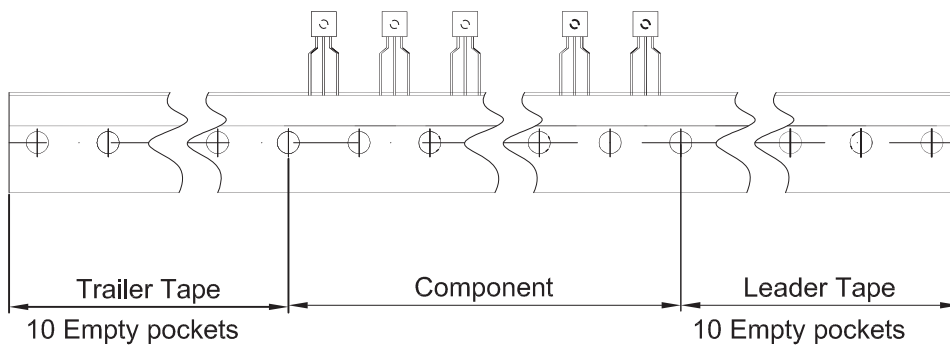

Package	Box	Box Size(mm)	Carton	Carton Size(mm)
TO-92	2000 pcs	333×162×43	20,000 pcs	350×340×250