

SOT-363 Plastic-Encapsulate Diodes

BAS16TW/MMBD4148TW SWITCHING DIODE

SOT-363

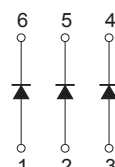
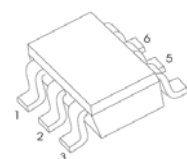

FEATURES

- Fast Switching Speed
- For General Purpose Switching Applications
- High Conductance

MARKING:

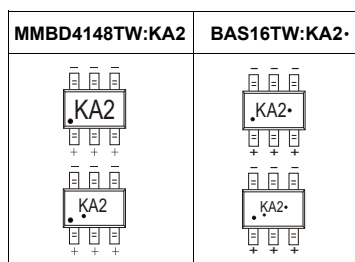

Solid dot = Pin1 indicate.

Solid dot = Green molding compound device, if none, the normal device.

Maximum Ratings and Electrical Characteristics, Single Diode @Ta=25°C

Parameter	Symbol	Limit	Unit
Non-Repetitive Peak Reverse Voltage	V_{RM}	100	V
Peak Repetitive Peak Reverse Voltage	V_{RRM}	75	V
Working Peak Reverse Voltage	V_{RWM}		
DC Blocking Voltage	V_R	53	V
RMS Reverse Voltage	$V_{R(RMS)}$		
Forward Continuous Current	I_{FM}	300	mA
Average Rectified Output Current	I_O	150	mA
Non-Repetitive Peak Forward Surge Current @t=8.3ms	I_{FSM}	2.0	A
Power Dissipation	P_d	200	mW
Thermal Resistance Junction to Ambient	$R_{\theta JA}$	625	°C/W
Junction Temperature	T_j	150	°C
Storage Temperature	T_{STG}	-55~+150	°C

Electrical Ratings @Ta=25°C

Parameter	Symbol	Min	Typ	Max	Unit	Conditions
Reverse breakdown voltage	$V_{(BR)}$	75			V	$I_R=10\mu A$
Forward voltage	V_{F1}			0.715	V	$I_F=1mA$
	V_{F2}			0.855	V	$I_F=10mA$
	V_{F3}			1.0	V	$I_F=50mA$
	V_{F4}			1.25	V	$I_F=150mA$
Reverse current	I_{R1}			1	μA	$V_R=75V$
	I_{R2}			25	nA	$V_R=20V$
Capacitance between terminals	C_T			2	pF	$V_R=0V, f=1MHz$
Reverse recovery time	t_{rr}			4	ns	$I_F=I_R=10mA$ $I_{rr}=0.1I_R, R_L=100\Omega$

Typical Characteristics

Forward Characteristics

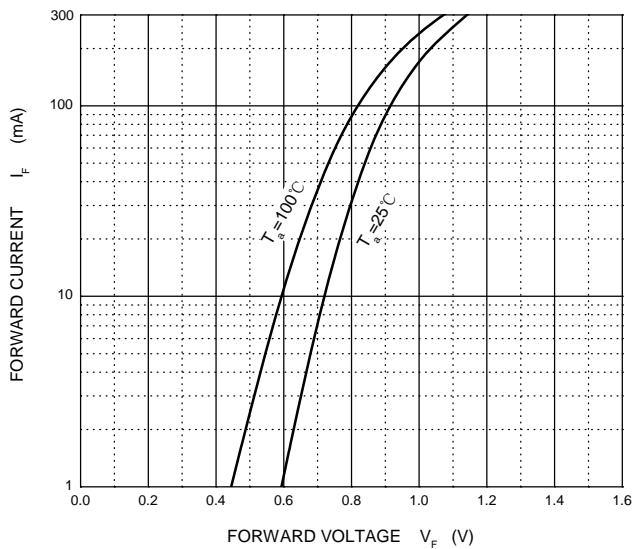

Reverse Characteristics

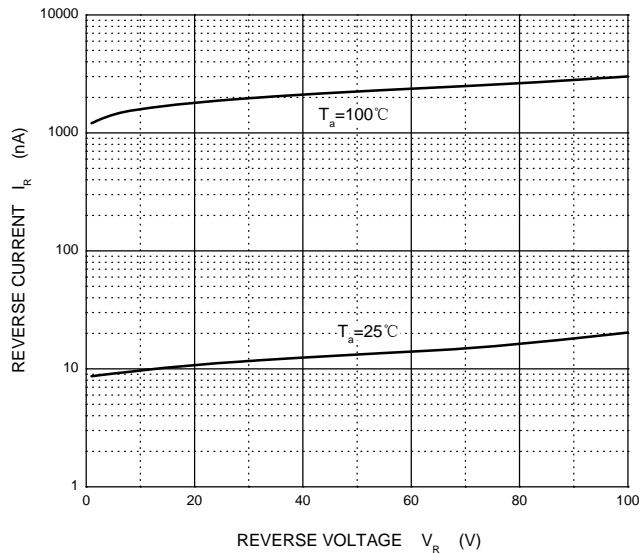

Capacitance Characteristics

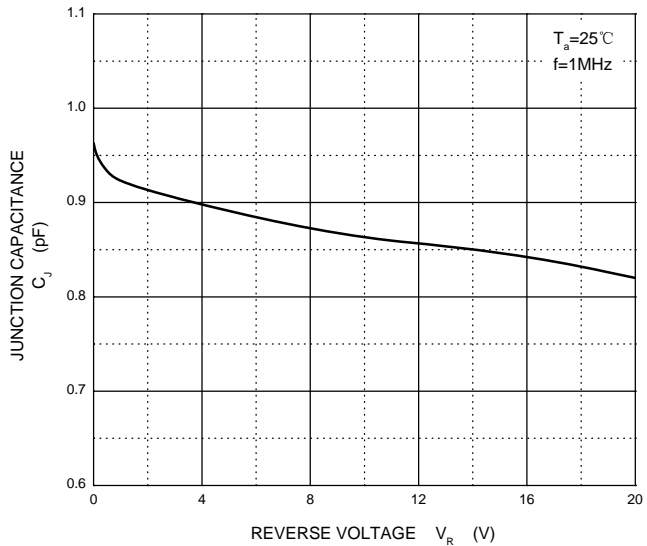

Power Derating Curve

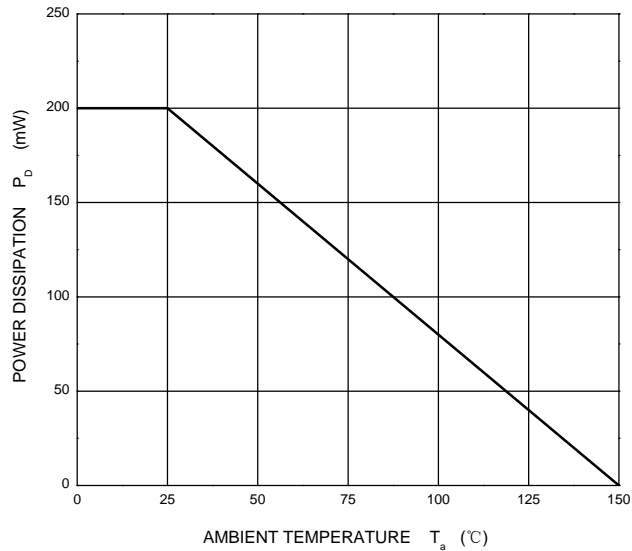

SOT-363 Package Outline Dimensions

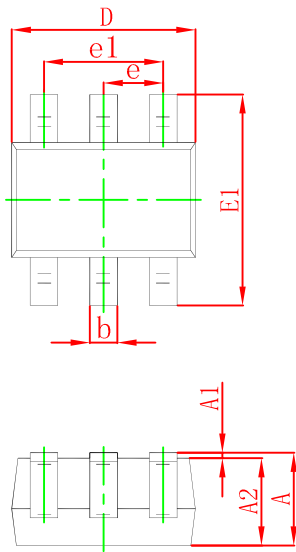

Symbol	Dimensions In Millimeters		Dimensions In Inches	
	Min	Max	Min	Max
A	0.900	1.100	0.035	0.043
A1	0.000	0.100	0.000	0.004
A2	0.900	1.000	0.035	0.039
b	0.150	0.350	0.006	0.014
c	0.100	0.150	0.004	0.006
D	2.000	2.200	0.079	0.087
E	1.150	1.350	0.045	0.053
E1	2.150	2.400	0.085	0.094
e	0.650 TYP		0.026 TYP	
e1	1.200	1.400	0.047	0.055
L	0.525 REF		0.021 REF	
L1	0.260	0.460	0.010	0.018
θ	0°	8°	0°	8°

SOT-363 Suggested Pad Layout

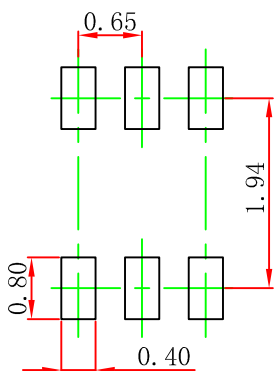

Note:

1. Controlling dimension: in millimeters.
2. General tolerance: $\pm 0.05\text{mm}$.
3. The pad layout is for reference purposes only.

NOTICE

JCET reserve the right to make modifications, enhancements, improvements, corrections or other changes without further notice to any product herein. JCET does not assume any liability arising out of the application or use of any product described herein.

SOT-363 Tape and Reel

SOT-363 Embossed Carrier Tape

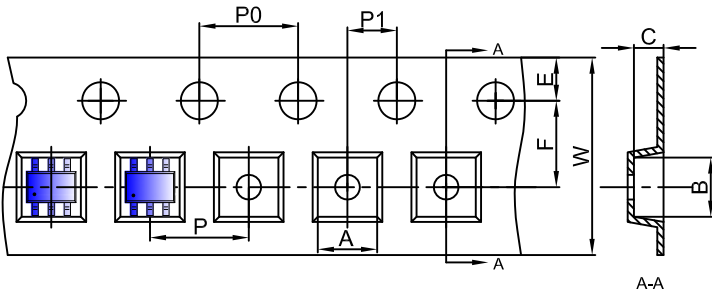

Packaging Description:

SOT-363 parts are shipped in tape. The carrier tape is made from a dissipative (carbon filled) polycarbonate resin. The cover tape is a multilayer film (Heat Activated Adhesive in nature) primarily composed of polyester film, adhesive layer, sealant, and anti-static sprayed agent. These reeled parts in standard option are shipped with 3,000 units per 7" or 17.8cm diameter reel. The reels are clear in color and is made of polystyrene plastic (anti-static coated).

Dimensions are in millimeter										
Pkg type	A	B	C	d	E	F	P0	P	P1	W
SOT-363	2.25	2.55	1.20	Ø1.50	1.75	3.50	4.00	4.00	2.00	8.00

SOT-363 Tape Leader and Trailer

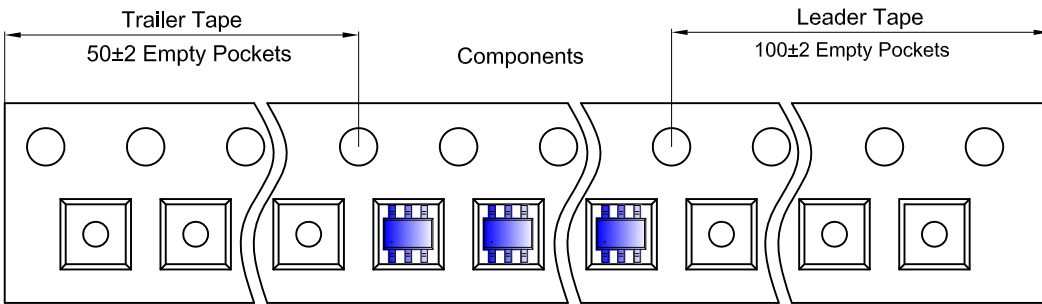

SOT-363 Reel

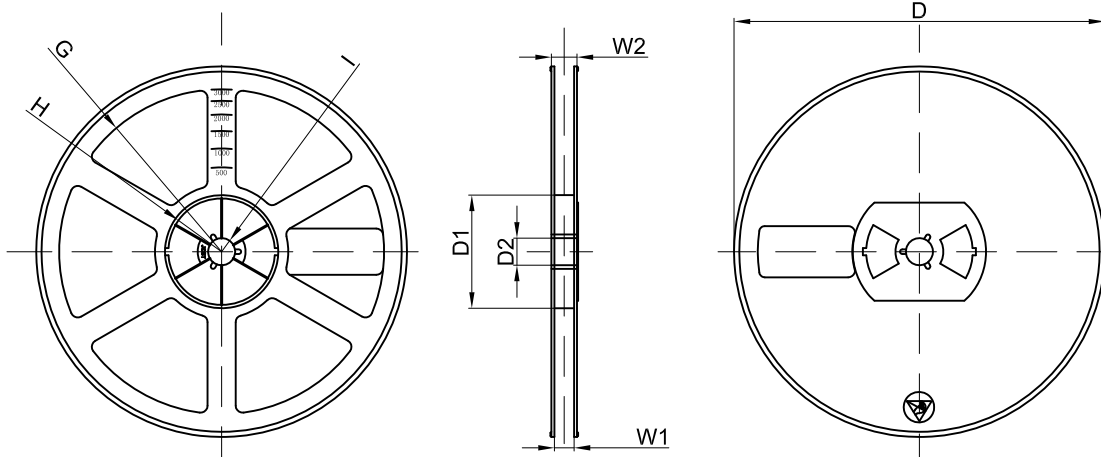

Dimensions are in millimeter								
Reel Option	D	D1	D2	G	H	I	W1	W2
7"Dia	Ø178.00	54.40	13.00	R78.00	R25.60	R6.50	9.50	12.30

REEL	Reel Size	Box	Box Size(mm)	Carton	Carton Size(mm)	G.W.(kg)
3000 pcs	7 inch	45,000 pcs	203×203×195	180,000 pcs	438×438×220	