

## Transient Voltage Suppressors - 1.5KE Series

### Features

1. Halogen-free
2. Rohs compliant
3. Typical maximum temperature coefficient
4.  $\Delta V_{BR} = 0.1\% \times V_{BR} @ 25^{\circ}\text{C} \times \Delta T$
5. Glass passivated Chip junction in DO-201 package
6. 1500W peak pulse capability at 10x1000 $\mu\text{s}$  waveform, repetition rate (duty cycles):0.01%
7. Fast response time: typically less than 1.0ps from 0 Volts to BV min
8. Excellent clamping capability
9. Low incremental surge resistance
10. Typical IR less than 5 $\mu\text{A}$  above 11V
11. High temperature soldering guaranteed: 260 $^{\circ}\text{C}/40$  seconds / 0.375", (9.5mm) lead length, 5lbs., (2.3kg)tension
12. Plastic package has underwriters laboratory flammability classification 94v-0
13. Matte Tin Lead-free plated

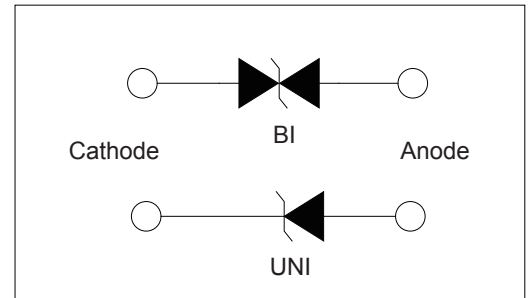
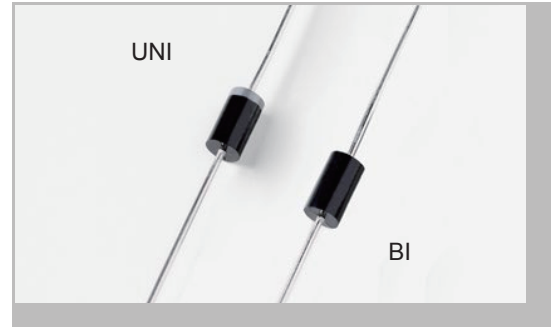

### Applications

TVS devices are ideal for the protection of I/O interfaces, VCC bus and other vulnerable circuits used in telecom, computer, industrial and consumer electronic applications.

### Mechanical Characteristics

Rating	Symbol	Value	Units
Peak Pulse Power Dissipation by 10x1000 $\mu\text{s}$ test waveform (Fig.1)(Note 1)	$P_{PPM}$	1500	Watts
Steady State Power Dissipation on infinite heat sink at TL=75 $^{\circ}\text{C}$ (Fig. 5)	$P_D$	6.5	Watts
Peak Forward Surge Current, 8.3ms Single Half Sine Wave Unidirectional only (Note 2)	$I_{FSM}$	200	Amps
Maximum Instantaneous Forward Voltage at 25A for Unidirectional only (Note 3)	$V_F$	3.5/5.0	V
Operating junction and Storage Temperature Range.	$T_J, T_{STG}$	-55 $^{\circ}\text{C}$ to 175 $^{\circ}\text{C}$	$^{\circ}\text{C}$
Typical Thermal Resistance Junction to Lead	$R_{\theta JL}$	15	$^{\circ}\text{C}/\text{W}$
Typical Thermal Resistance Junction to Ambient	$R_{\theta JA}$	75	$^{\circ}\text{C}/\text{W}$
Reverse current	$I_F$	100	A

#### Notes:

1. Non-repetitive current pulse, per Fig. 3 and derated above  $T_A = 25^{\circ}\text{C}$  per Fig. 2.
2. Measured on 8.3ms single half sine wave or equivalent square wave, duty cycle=4 per minute maximum.
3.  $V_F < 3.5\text{V}$  for devices of  $V_{BR} < 200\text{V}$  and  $V_F < 5.0\text{V}$  for devices of  $V_{BR} > 201\text{V}$ .

# Transient Voltage Suppressors - 1.5KE Series

## Electrical Characteristics

Type Number		Reverse Stand-Off Voltage VRWM(V)	Breakdown Voltage Min.@IT		Test Current IT(mA)	Maximum Clamping Voltage@IPP VC(V)	Peak Pulse Current IPP(A)	Reverse Leakage @VRWM IR(μA)
(UNI)	(BI)		VBR MIN.(V)	VBR.MAX.(V)				
1.5KE6.8A	1.5KE6.8CA	5.80	6.45	7.14	10	10.5	144.8	1000
1.5KE7.5A	1.5KE7.5CA	6.40	7.13	7.88	10	11.3	134.5	500
1.5KE8.2A	1.5KE8.2CA	7.02	7.79	8.61	10	12.1	125.6	200
1.5KE9.1A	1.5KE9.1CA	7.78	8.65	9.50	1	13.4	113.4	50
1.5KE10A	1.5KE10CA	8.55	9.50	10.50	1	14.5	104.8	10
1.5KE11A	1.5KE11CA	9.40	10.50	11.60	1	15.6	97.4	5
1.5KE12A	1.5KE12CA	10.20	11.40	12.60	1	16.7	91.0	5
1.5KE13A	1.5KE13CA	11.10	12.40	13.70	1	18.2	83.5	5
1.5KE15A	1.5KE15CA	12.80	14.30	15.80	1	21.2	71.7	5
1.5KE16A	1.5KE16CA	13.60	15.20	16.80	1	22.5	67.6	5
1.5KE18A	1.5KE18CA	15.30	17.10	18.90	1	25.2	60.3	5
1.5KE20A	1.5KE20CA	17.10	19.00	21.00	1	27.7	54.9	5
1.5KE22A	1.5KE22CA	18.80	20.90	23.10	1	30.6	49.7	5
1.5KE24A	1.5KE24CA	20.50	22.80	25.20	1	33.2	45.8	5
1.5KE27A	1.5KE27CA	23.10	25.70	28.40	1	37.5	40.5	5
1.5KE30A	1.5KE30CA	25.60	28.50	31.50	1	41.4	36.7	5
1.5KE33A	1.5KE33CA	28.20	31.40	34.70	1	45.7	33.3	5
1.5KE36A	1.5KE36CA	30.80	34.20	37.80	1	49.9	30.5	5
1.5KE39A	1.5KE39CA	33.30	37.10	41.00	1	53.9	28.2	5
1.5KE43A	1.5KE43CA	36.80	40.90	45.20	1	59.3	25.6	5
1.5KE47A	1.5KE47CA	40.20	44.70	49.40	1	64.8	23.5	5
1.5KE51A	1.5KE51CA	43.60	48.50	53.60	1	70.1	21.7	5
1.5KE56A	1.5KE56CA	47.80	53.20	58.80	1	77.0	19.7	5
1.5KE62A	1.5KE62CA	53.00	58.90	65.10	1	85.0	17.9	5
1.5KE68A	1.5KE68CA	58.10	64.60	71.40	1	92.0	16.5	5
1.5KE75A	1.5KE75CA	64.10	71.30	78.80	1	103.0	14.8	5
1.5KE82A	1.5KE82CA	70.10	77.90	86.10	1	113.0	13.5	5
1.5KE91A	1.5KE91CA	77.80	86.50	95.50	1	125.0	12.2	5
1.5KE100A	1.5KE100CA	85.50	95.00	105.00	1	137.0	11.1	5
1.5KE110A	1.5KE110CA	94.00	105.00	116.00	1	152.0	10.0	5
1.5KE120A	1.5KE120CA	102.00	114.00	126.00	1	165.0	9.20	5
1.5KE130A	1.5KE130CA	111.00	124.00	137.00	1	179.0	8.50	5
1.5KE150A	1.5KE150CA	128.00	143.00	158.00	1	207.0	7.30	5
1.5KE160A	1.5KE160CA	136.00	152.00	168.00	1	219.0	6.60	5
1.5KE170A	1.5KE170CA	145.00	162.00	179.00	1	234.0	6.50	5
1.5KE180A	1.5KE180CA	154.00	171.00	189.00	1	246.0	6.20	5
1.5KE200A	1.5KE200CA	171.00	190.00	210.00	1	274.0	5.50	5
1.5KE220A	1.5KE220CA	185.00	209.00	231.00	1	328.0	4.60	5
1.5KE250A	1.5KE250CA	214.00	237.00	263.00	1	344.0	4.40	5
1.5KE300A	1.5KE300CA	256.00	285.00	315.00	1	414.0	3.70	5
1.5KE350A	1.5KE350CA	300.00	332.00	368.00	1	482.0	3.20	5
1.5KE400A	1.5KE400CA	342.00	380.00	420.00	1	548.0	2.80	5
1.5KE440A	1.5KE440CA	376.00	418.00	462.00	1	602.0	2.50	5
1.5KE480A	1.5KE480CA	408.00	456.00	504.00	1	658.0	2.30	5

For bidirectional type having VR of 10 volts and less, the IR limit is double.

For parts without A, the VBR is +10% and VC is 5% higher than with A parts.

# Transient Voltage Suppressors - 1.5KE Series

## Ratings and Characteristic Curves

Figure 1 - Peak Pulse Power Rating Curve

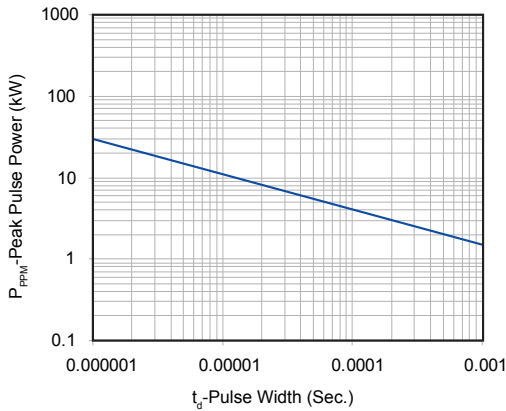

Figure 2 - Pulse Derating Curve

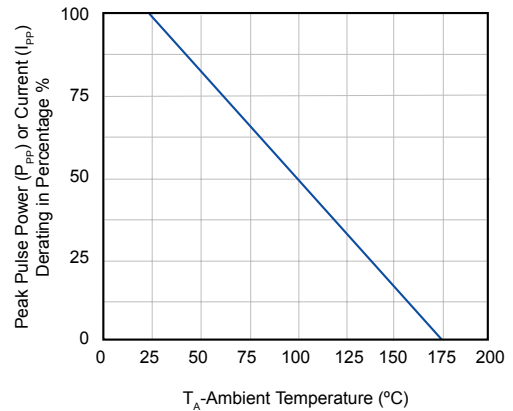

Figure 3 - Pulse Waveform

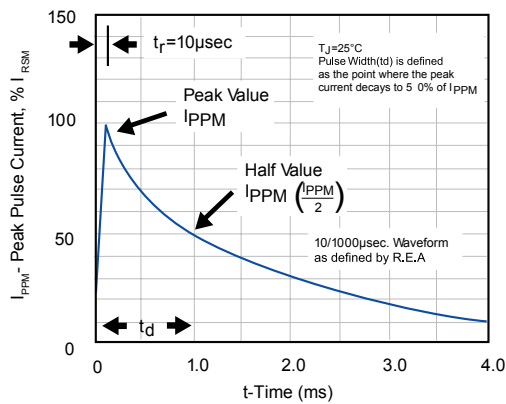

Figure 4 - Typical Junction Capacitance

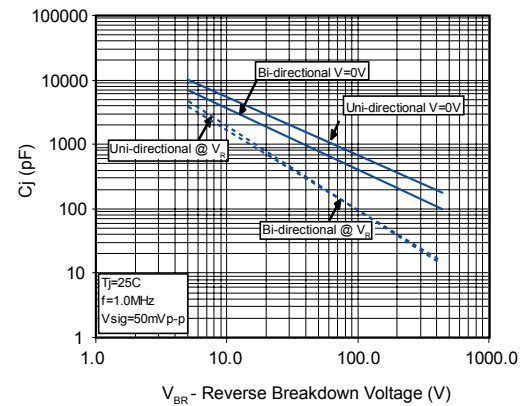

Figure 5 - Steady State Power Derating Curve

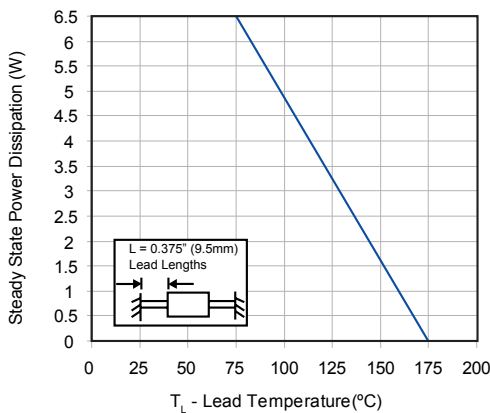
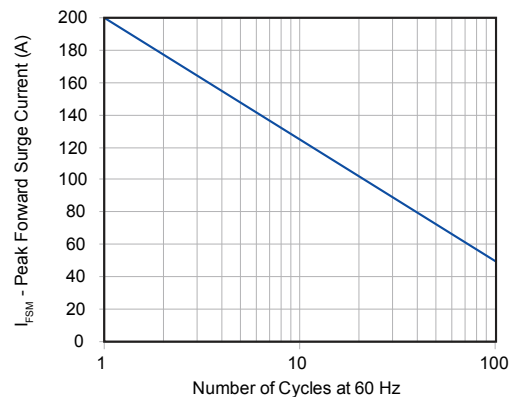

Figure 6 - Maximum Non-Repetitive Peak Forward Surge Current Uni-Directional Only



# Transient Voltage Suppressors - 1.5KE Series

## Soldering Parameters

	Reflow Condition	Lead-free assembly
Pre Heat	- Temperature Min ( $T_{s(min)}$ )	150°C
	- Temperature Max ( $T_{s(max)}$ )	200°C
	- Time (min to max) ( $t_s$ )	60-180 secs
Average ramp up rate (Liquidus Temp ( $T_L$ ) to peak)		3°C/second max
$T_{s(max)}$ to $T_L$ - Ramp-up Rate		3°C/second max
Reflow	- Temperature ( $T_L$ ) (Liquidus)	217°C
	- Time (min to max) ( $t_s$ )	60-150 seconds
Peak Temperature ( $T_P$ )		260 <sup>+0/-5</sup> °C
Time within 5°C of actual peak Temperature ( $t_p$ )		20-40 seconds
Ramp-down Rate		6°C/second max
Time 25°C to peak Temperature ( $T_P$ )		8 minutes Max.
Do not exceed		280°C

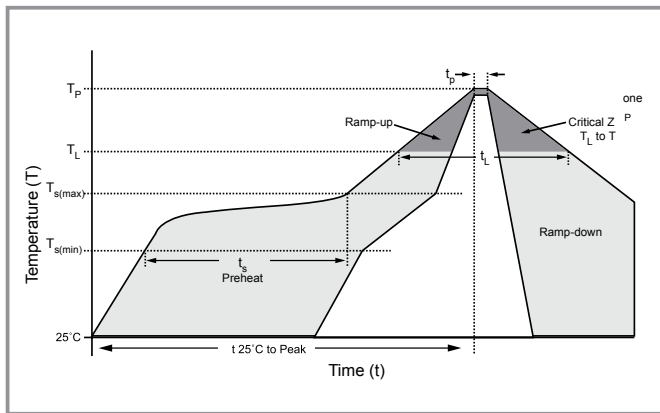

## Physical Specifications

Weight	0.045oz., 1.2g
Case	JEDEC DO-201 molded plastic body over passivated junction.
Polarity	Color band denotes the cathode except Bipolar.
Termina	Matte Tin axial leads, solderable per JESD22-B102D.

## Environmental Specifications

Temperature Cycle	JESD22-A104
Pressure Cooker	JESD 22-A102
High Temp. Storage	JESD22-A103
HTRB	JESD22-A108
Thermal Shock	JESD22-A106

## Flow/Wave Soldering

Peak Temperature :	265°C
Dipping Time :	10 seconds
Soldering :	1 time

# Transient Voltage Suppressors - 1.5KE Series

## Part Numbering System

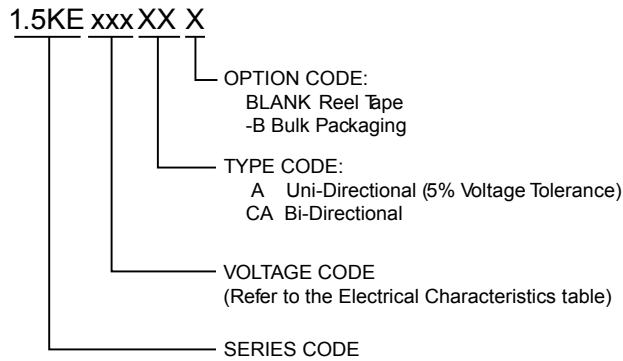

## Packaging

Part Number	Component Package	Quantity	Packaging Option	Packaging Specification
1.5KExxxXX	DO-201	1000	Tape & Reel	ELA STD RS-296E
1.5KExxxXX-B	DO-201	500	BULK	Concord Packing Spec

## Warehouse Storage Conditions of Products

- Storage Conditions:
  1. Storage Temperature: -10°C~+40°C
  2. Relative Humidity: ≤75%RH
  3. Keep away from corrosive atmosphere and sunlight.
- Period of Storage: 1 year